

Skokie Public Library
Furniture Procurement:
2020 Library Renovation Project
5215 S. Oakton Street
Skokie, Illinois 60077

Issued for Bid:
November 7, 2019

NOTICE TO BIDDERS

Skokie Public Library is accepting sealed bids for furniture procurement in connection with the 2020 Library Renovation Project at the Skokie Public Library. Bid packages are available for pickup from Skokie Public Library at 5215 S. Oakton Street, Skokie, Illinois 60077, and on the Library's website, at the following address: <https://skokielibrary.info/about/rfps/>, starting on November 7, 2019. The bid opening is scheduled for Tuesday, November 26, 2019 at 10:00 a.m. at Skokie Public Library in the Book Discussion Room.

INSTRUCTIONS TO BIDDERS

1. **Scope and Term of Services.** Skokie Public Library (the “Library”) is accepting sealed bids for furniture procurement as required for the Library’s 2020 Renovation Project, which is located at 5215 S. Oakton Street, Skokie, Illinois 60077.
2. **Contact Information.** Any questions about this bid package must be emailed to the Library’s Director, Richard Kong, at rkong@skokieliibrary.info by November 18, 2019 at 5:00 p.m.
3. **Pre-Bid Meeting.** Not applicable.
4. **Notification of Addenda.** The Library will endeavor to respond to all timely and relevant questions from Bidders, as determined in the Library’s sole discretion, and will compile all such questions and the corresponding answers in one or more Bid Addenda, which will be posted by November 20, 2019 on the Library’s website at: <https://skokieliibrary.info/about/rfps/>. Each Bidder is responsible for obtaining from this website location and reviewing any and all Bid Addenda posted by the Library. Bidder shall acknowledge receipt of all addenda in the space provided on the Bid Form.
5. **Tax Exempt.** The Library is tax-exempt. Bidder shall prepare its bid accordingly. The Library’s tax exemption number is E9988-9684-07.
6. **Bid Preparation.** Bidder shall complete and submit all forms provided in this bid package. All forms shall be free from interlineations and erasures. Failure to properly complete and return all forms may subject the bid to rejection. Each bid submittal with all completed forms shall be sealed in an opaque envelope and labeled “**BID FOR FURNITURE PROCUREMENT – DO NOT OPEN PRIOR TO BID DATE**”. Each bid submittal shall be labeled with the name and address of the Bidder and shall be addressed to **Richard Kong, Director, Skokie Public Library, 5215 S. Oakton Street, Skokie, Illinois 60077.**
7. **Bid Bond.** Not applicable.
8. **Non-Conforming Bids.** Any bid submittal that contains or purports to contain qualifications, terms, conditions, or provisions in addition to or in conflict with this bid package, or that omits required information or documents, may be rejected by the Library as non-responsive. Bidders may submit unit pricing for any or all specified items of furniture. Any unit price bid that omits bid pricing or other required information for that respective item may be rejected as non-responsive.
9. **Bid Submittal.** All bids shall be submitted to **Richard Kong, Director, Skokie Public Library, 5215 S. Oakton Street, Skokie, Illinois 60077.** The deadline for submitting and delivering bids is **Tuesday, November 26, 2019 at 10:00 a.m.**
10. **Bid Form.** Bidders shall complete the attached Exhibit A – Furniture Schedule, and submit it as an attachment to the enclosed Bid Form. Bidders may bid on some or all specified furniture items. For each item on which Bidder intends to bid, please submit on the Furniture Schedule the lead time for the item, along with a unit cost and extended cost based on the stated quantity, for **each** of three procurement periods: May 2020, October 2020, and February 2021. **Bidders shall not include in its unit prices on the Furniture Schedule any charges for taxes, freight, shipping, delivery, and/or assembly, but may itemize such charges in a separate**

document included with the bid submittal.

11. **Bidder's Representation.** BY SUBMITTING A BID, THE BIDDER REPRESENTS TO THE LIBRARY THAT IT HAS CAREFULLY REVIEWED THIS BID PACKAGE, AND ALL CONTRACT DOCUMENTS, AND IS NOT AWARE OF ANY VAGUE, AMBIGUOUS OR INCONSISTENT TERMS CONTAINED THEREIN.

12. **Withdrawal of Bids.** Any bid may be withdrawn and/or resubmitted prior to the time of bid opening.

13. **Bid Opening.** On **November 26, 2019, at 10:00 a.m.**, all bids will be opened and read aloud by an employee or agent of the Library. The bid opening will occur in the Library's Book Discussion Room, located at 5215 S. Oakton Street, Skokie, Illinois 60077.

14. **Firm Bids.** All bids submitted to and opened by the Library, including and not limited to all unit prices contained therein, shall be firm and irrevocable for a period of sixty (60) days after the date of bid opening. At any time within this period, the Library may, on an item by item basis, award multiple contracts to each lowest responsive and responsible bidder for each furniture item.

15. **Acceptance or Rejection of Bids.** The Library reserves the right to waive any non-material variances in bid submittals and/or irregularities in the bid process, to award multiple contracts to the lowest responsive and responsible Bidder for each specified furniture item, and/or to reject all bids, all to the fullest extent allowed by law. Each low Bidder for each furniture item will be determined on an item by item basis, based upon unit cost. **The low bid determination shall not include finalized charges for freight, shipping, delivery, and/or assembly, and these items will be confirmed and finalized between the Library and Bidder at a later time. Any excessive or unreasonable charges for these items may, in the Library's discretion, constitute the basis for rejection of the bid or termination of the contract.**

16. **Award of Contract.** The Library's Board of Trustees will award multiple contracts to the lowest responsive and responsible Bidder for each specified furniture item based upon unit cost. The Library's actual quantities ordered may vary from quantities specified, which is only an estimate. Responsiveness will be determined based upon compliance with these Instructions to Bidders. Responsibility will be determined by the Library based upon the information provided by each Bidder with its bid submittal. Upon receiving notice of such award, the successful Bidder shall be known as the "Contractor," and shall be bound to perform the contractual duties established by this bid package, including without limitation the duties established in the Instructions to Bidders, Conditions of the Contract, Contract Specifications, and Bid Addenda, if any.

END OF INSTRUCTIONS TO BIDDERS.

CONDITIONS OF CONTRACT

1. **Record Keeping.** Contractor shall keep complete and accurate records of furniture purchased and sold in connection with the contract. Contractor shall provide the Library access to such records upon a request by the Library.
2. **Furniture Documentation and Warranties.** Upon delivery of each item of furniture, Contractor shall furnish to the Library's designee all documentation pertaining to each item, including and not limited to all assembly and installation instructions, care instructions, product information, and warranty documents. Contractor shall cause all manufacturer's warranties to be assigned to the Library as owner.
3. **Right to Audit.** The Library may audit the Contractor's records related to the purchase, sale, delivery and assembly of furniture. Contractor shall fully cooperate with all personnel authorized by the Library to conduct any audit.
4. **Records Retention.** Contractor shall retain such records related to this purchase and sale of furniture for a period of three (3) years after the delivery of all ordered furniture, or a longer period if required by law. If any audit has been requested and is not completed, the records shall be retained beyond the three (3) year period as long as required for completion of the audit.
5. **Payment and Performance Bonds.** Not applicable.
6. **No Delegation or Assignment.** Contractor shall not assign any right or delegate any duty under this contract to any third party without the Library's prior written consent. Any attempted assignment or delegation without such prior written consent shall be void.
7. **No Third-Party Beneficiaries.** There are no third-party beneficiaries to this contract.
8. **Independent Contractor.** Contractor is an independent contractor and not an agent of the Library. Contractor's employees are not employees of the Library and are not entitled to salary or benefits from the Library. Contractor has no authority to act on behalf of the Library except to the limited extent required by this contract. Contractor shall not represent to any third person that Contractor or any of its employees are agents of the Library.
9. **Waiver.** The Library's waiver of any breach or default under any provision of this contract shall not be deemed to constitute a waiver of such provision for any subsequent breach or default of the same or any other provision. The disbursement or acceptance of any payment by the Library shall not be deemed to constitute a waiver of any prior occurring breach or default by Contractor of any provision of the contract regardless of the knowledge of the Library of such breach or default at the time of its disbursement or acceptance of such payment.
10. **Indemnity.** Contractor shall indemnify, defend and hold harmless the Library, its Board of Trustees, individual board members, administrators, employees, agents and representatives (collectively the "Indemnitees") from and against any and all claims, demands, causes of action, losses, liabilities, and damages, including reasonable attorneys' fees and court costs, to the extent arising from Contractor's performance and/or breach of this contract, or from any negligent act or omission of the Contractor or its employees or subcontractors.

11. **Defenses and Immunities.** No term or condition of this contract is intended to or shall be deemed to waive any common law or statutory immunity or defense available to the Library, and the Library expressly reserves all applicable immunities and defenses.

12. **Insurance.** Contractor shall procure and maintain through an insurance company or companies licensed to conduct business in Illinois insurance with coverage and limits as specified below, and shall cause "Skokie Public Library" to be included as an additional insured on these policies by endorsement. All such insurers shall carry a Best Key Guide Rating of A / VIII. The commercial general liability and automobile policies shall be endorsed to reflect that coverage is primary and noncontributory with respect to any other insurance available to the Library. The commercial general liability policy shall by endorsement provide contractual liability coverage including the indemnity obligations provided in this contract.

Each such policy shall include by endorsement a requirement of at least 30 days' written notice to the Library prior to any termination, cancellation or material amendment to that policy. Upon award of this contract, and promptly upon the renewal of such policies during the term of this contract, Contractor shall furnish certificate(s) of insurance, policies, and endorsements to the Library reflecting the coverages required.

The type and limits of insurance required are as follows:

<u>Type</u>	<u>Limits</u>
Commercial General Liability	
Per Occurrence:	\$1,000,000
Aggregate:	\$2,000,000
Automobile Liability:	\$1,000,000 combined single limit
Umbrella / Excess:	\$2,000,000
Workers' Compensation:	Statutory Limit

13. **Payment.** On a monthly basis during performance of the contract, Contractor shall furnish detailed monthly invoices to the Library in a form acceptable to the Library, detailing and itemizing each piece of furniture delivered to and assembled at the Library in the previous month in connection with this contract. The Library may at any time direct Contractor to change the formatting of its invoices or to add more details as required by the Library. Contractor shall deliver invoices to the Library no later than the first day of each month. The Library will process invoices in accordance with the Local Government Prompt Payment Act, 50 ILCS 505/1, *et seq.*

14. **Termination.** The Library may terminate this contract at any time, for any reason or no reason, in the Library's sole discretion, upon written notice to Contractor. If such termination is without cause, the Library will pay for the furniture delivered up until the date of termination. If such termination is based on the Contractor's material breach of contract, the Library shall have no further obligation to pay Contractor. Whether or not the Library exercises such right of termination, Contractor hereby waives any claim against the Library related to incidental, consequential, or special damages, including and not limited to lost profits.

15. **Prevailing Party.** In the event of any litigation, arbitration, or binding dispute

resolution arising from this contract, Contractor shall pay the Library's reasonable attorneys' fees and court costs to the extent the Library is determined to be the prevailing party.

16. **Choice of Law.** This contract shall be governed by, subject to, and construed in accordance with the laws of the State of Illinois without regard to conflict of law principles. Venue for any dispute shall be Cook County, Illinois. Contractor hereby consents to personal jurisdiction in Illinois with respect to all claims arising from this contract.

17. **Integration.** This contract includes the Instructions to Bidders, these Conditions of Contract, and the Contract Specifications, all as contained in this bid package; together with any later-issued Addenda, Contractor's Bid Submittal, and the Library's Notice of Award, these documents are collectively known as the "contract" or "Contract Documents." The Contract Documents constitute the entire agreement between the Library and Contractor with respect to their subject matter and supersede any prior oral or written agreement between the parties. This contract may not be cancelled or amended orally, but only by the written agreement of both parties.

18. **Execution of Contract.** Upon the Library's Notice of Award of this contract to the Contractor, Contractor's bid shall be deemed accepted and a binding contract shall be formed, consisting of the Contract Documents.

END OF CONDITIONS OF CONTRACT.

CONTRACT SPECIFICATIONS

1. See Exhibit A – Furniture Schedule, which is attached and incorporated by this reference. For each item of furniture on which Bidder desires to bid, provide lead time, unit costs, and extended costs for each delivery period in the spaces provided on the Furniture Schedule. Bidder may in a separate document include charges for freight, shipping, delivery, and/or assembly, which will be addressed and finalized prior to or at the time of award and purchase. Submit a completed Furniture Schedule with your bid submittal.

2. **Prevailing Wage Act.** The following furniture items will be affixed to the building and thus require the installing Contractor to pay prevailing wages in accordance with the Cook County Prevailing Wage Rates posted on 7/15/19, which are located here: <https://www2.illinois.gov/idol/Laws-Rules/CONMED/Documents/2019%20Rates/July%2015/Cook.pdf>, and to make, keep, and file with the Library certified payroll in accordance with Section 5 of the Prevailing Wage Act, 820 ILCS 130/0.01 *et seq.*

- a. See Exhibit A – Furniture Schedule, Key Column, Items S2, S5, S6, S7, S10, S11, S12, S13, S14, S15 and S16. The successful bidder for these items is obligated to deliver and install these items and thus shall comply with the prevailing wage requirements specified above.
- b. See Exhibit A – Furniture Schedule, Key Column, Items T39 and T40. Bidder shall deliver and assemble these items, but the required hardwired electrical connections shall be performed by the Library's electrical contractor, who shall be required to comply with the prevailing wage requirements specified above. The successful bidder for these items is thus **not required** to comply with the prevailing wage requirements specified above.

**EXHIBIT A – FURNITURE SCHEDULE PREPARED
BY ANDREW BERMAN ARCHITECT DATED 11.6.19**

Estimated delivery date:	May 2020	Oct 2020	Feb 2021
--------------------------	----------	----------	----------

Key	Furniture Type	Location	Mfr	Model	Finishes	Dimension	Lead Time (wk)	Phase 1: 2nd floor			Phase 2: 1st fl West Side			Phase 3: 1st fl East Side		
								Unit Cost	Qty	Extended Cost	Unit Cost	Qty	Extended Cost	Unit Cost	Qty	Extended Cost

EXISTING FURNITURE TO BE REUSED (FOR REFERENCE ONLY)

EX-C1	Existing chair	101 East Vestibule, 126 Reading Room around Swan courtyard, 209 East Seating	Knoll	MR Chair with arms						4			14			4
EX-C2	Existing chair	126 Reading room around Swan courtyard, 209 East Seating	Knoll	Brno Chair						16						
EX-C3	Existing club chair	126 Reading Room around Swan courtyard, 209 East seating	Knoll	Pfister Lounge Chair						16			4			
EX-C4	Existing chair with casters	163 Lab	KI	Grazie									16			
EX-C5	Existing bar stool	156 Young Adult	Steelcase	Scoop stool									6			
EX-C6	Existing upholstered bench	101 East Vestibule	Knoll	Florence Bench		19"w x 61"l										2
EX-C7	Existing upholstered bench	104 Gallery	--	Black bench, painted silver legs		21"w x 54"l							1			3
EX-C8	Existing upholstered bench	132 Lockers	KI	Kurv Bench, non-tufted		30"w x 61"l										1
EX-T1	Existing round glass occasional table	126 Reading room around Swan courtyard, 209 East seating	Knoll	MR Table		28.5"ø				2			6			
EX-T2	Existing square glass occasional table		Knoll	Barcelona Table Replace glass top with M4: 3'-8"ø 3/4" thick tempered glass with polished edge.		40" x 40"				4						
EX-T3	Existing square glass occasional table		Knoll	Barcelona Table		36" x 36"							2			
EX-T4	Existing fliptop table	165 Video	KI	Pirouette Nesting Table, casters		24" x 48"							2			
EX-T5	Existing fliptop table	148 Meeting Room	KI	Pirouette Nesting Table, casters		24" x 60"							4			
EX-T6	Existing fliptop table	146 Book Discussion Room	KI	Pirouette Nesting Table, casters		30" x 72"							7			
EX-T7	Existing bar hgt table	156 Young Adult	Steelcase	Campfire table		42"h							1			
EX-T8	Existing round computer table	163 Lab	--	Wood table		72"ø							3			

CHAIRS

C1A	Reading chair with wood legs	2nd Floor	Vitra	HAL Wood - plastic shell, 4 wood legs	Seat: 31 Warm grey Legs: 10 Natural Oak					86						
C1B	Reading chair with wood legs	122 Cafe, 2nd Floor	Vitra	HAL Wood - plastic shell, 4 wood legs	Seat: 65 Orange Legs: 10 Natural Oak					54			14			
C2	Reading armchair with wood legs, with seat pad	244 Reading Rm	Vitra	HAL Wood - plastic shell and arm, 4 wood legs - upholstered seat pad	Seat: 04 White Legs: 10 Natural Oak Upholstery: Pallas Nappa Mulberry					24						
C2 ADD ALT	Reading armchair	244 Reading Rm	Maruni	Hiroshima armchair high 2975-22 - no seat pad	Oak, clear urethane finish					36						
C3A	Reading chair with metal legs, color 1	Staff offices	Vitra	HAL Tube Stackable - plastic shell, 4 metal legs, glides for carpet - stacks 6	Seat: 31 Warm grey Legs: standard chrome Glides: 30 Basic dark								38			
C3B	Reading chair with metal legs, color 2	188 Classroom, 166 Boombox	Vitra	HAL Tube Stackable - plastic shell, 4 metal legs, glides for hard floor - stacks 6	Seat: 65 Orange Legs: standard chrome Glides: 30 Basic dark											32
C4A	Chair with casters, color 1	163 Lab, 170 YS entrance	Vitra	HAL Studio - adjustable height swivel base with casters	Seat: 31 Warm grey Base: standard basic dark								9			3
C4B	Chair with casters, color 2	166 Boombox, 218 Makerspace, 222 Computers commons	Vitra	HAL Studio - adjustable height swivel base with casters	Seat: 65 Orange Base: standard basic dark					38						8

SKOKIE PUBLIC LIBRARY
 FURNITURE SCHEDULE
 ISSUED FOR BID
 DATE: 11.06.2019

ANDREW BERMAN ARCHITECT

Key	Furniture Type	Location	Mfr	Model	Finishes	Dimension	Lead Time (wk)	Estimated delivery date:			May 2020			Oct 2020			Feb 2021		
								Phase 1: 2nd floor			Phase 2: 1st fl West Side			Phase 3: 1st fl East Side					
								Unit Cost	Qty	Extended Cost	Unit Cost	Qty	Extended Cost	Unit Cost	Qty	Extended Cost			
C5	Armchair with casters	222 Computers commons	Vitra	HAL Armchair Studio - integral arms - adjustable height swivel base with casters	Seat: 65 Orange Base: standard basic dark	30"w x 30"d x 13 3/4"-19 1/4"h seat			24										
C6	Counter stool	166 Boombox, 218 Makerspace	Vitra	HAL Stool Medium - plastic shell, 4 metal legs, glides for hard floor	Seat: 65 Orange Legs: standard chrome Glides: 30 Basic dark	19.5"w x 19.25"d x 25.5"h seat			16								9		
C7A	Reading chair for Teen and Kids, color 1	156 YA, 185 YS	Vitra	Tip Ton chair	37 Glacier blue	20"w x 21 3/4"d x 31"h, 18 1/2"sh							14						
C7B	Reading chair for Teen and Kids, color 2	156 YA, 185 YS	Vitra	Tip Ton chair	78 Mango	20"w x 21 3/4"d x 31"h, 18 1/2"sh							6					28	
C7C	Reading chair for Teen and Kids, color 3	156 YA, 185 YS	Vitra	Tip Ton chair	35 Basalt	20"w x 21 3/4"d x 31"h, 18 1/2"sh												7	
C8	Staff counter stool	Help desk	Allemuir	Kin Counter stool - low back plastic shell, wood legs	Seat: Aubergine Legs: standard Ash	24.5"h seat			2				2					3	
C9	Staff Office armchair with casters	Staff offices	Steelcase	Think chair with arms 465A300 - 3D knit - no headrest, no coat hanger - adjustable lumbar - standard range cylinder - plastic base with hard casters - no soil retardant, no fire code	Frame: 4799 Platinum metallic Back: 3D Knit 5092 Graphite Seat: Cogent Connect 5S25 Graphite				5				14					2	
C10A	Stacking chair	106 MR Room, 211 Business Center	KI	Opt4 Stacking Side Chair 04BSPB - solid poly back, solid poly seat - sled base	Seat: Black Base: chrome	19 3/4"w x 21 13/16" x 32 3/16" h x 17 3/4"h seat			64									74	
C10B	Stacking armchair	106 MR Room, 211 Business Center	KI	Opt4 Stacking Armchair 04LWAPSPB - solid poly back, solid poly seat - 4 legs - stacks 6 on floor	Seat: Black Base: chrome	24 5/8"w x 21 13/16" x 32 3/16" h x 17 3/4"h seat			6									6	
C11	Stacking chair dolly	106 MR Room, 211 Business Center	KI	Opt4 Dolly 04DA.BL	standard	22 3/8"w x 32"d x 16 3/4"h													
C12A	Exterior chair, color 1	123 Cafe Patio, 124 South Courtyard, 125 Reading Patio, 169 N. Courtyard	Fermob	Luxembourg side chair 4101 - aluminum tube frame and slats - stacks 10	29 Verveine/ Verbena	49cm w x 57cm d x 49cm h seat							12					8	
C12B	Exterior chair, color 2	123 Cafe Patio, 124 South Courtyard, 125 Reading Patio, 169 N. Courtyard	Fermob	Luxembourg side chair 4101 - aluminum tube frame and slats - stacks 10	38 Gris metal/ Steel grey	49cm w x 57cm d x 49cm h seat							24						
C12C	Exterior chair, steel	3rd floor staff terrace	Fermob	Luxembourg side chair 4121 - steel tube frame and slats - stacks 10	29 Verveine/ Verbena	49cm w x 57cm d x 49cm h seat			16										
C13	Exterior lounge chair	124 South Courtyard	Fermob	Luxembourg low armchair 4104 - aluminum tube frame and slats - armrests	29 Verveine/ Verbena	70cm w x 86cm d x 40.5cm h seat							6						
C14	Exterior bench	124 South Courtyard	Fermob	Luxembourg 3/4 seaters bench 4110 - aluminum tube frame and slats	29 Verveine/ Verbena	145cm w x 42.5 cm d x 48.8cm h seat							2					4	
C15A	Movable stool for Teens, color 1	156 Young Adult	Vitra	Stool-Tool - polypropylene - stacks 10	24 light grey	14.25"w x 24.5"d x 29.5"h x 19"h seat							5						
C15B	Movable stool for Teens, color 2	156 Young Adult	Vitra	Stool-Tool - polypropylene - stacks 10	76 industrial green	14.25"w x 24.5"d x 29.5"h x 19"h seat							5						
C16	Cushions for storytelling	186 Storytelling	SixInch	Tingle cushion with Flexplus coating	Light blue (qty 7), Metallic Space (qty 7), Purple (qty 8), Silver (qty 8)	13"ø x 5"h												30	
C17	Round foam pouf, low	185 Youth Services	SixInch	Bubble pouf with Flexplus coating	Light blue (qty 2), Metallic Space (qty 2), Purple (qty 2), Silver (qty 2)	18"ø x 12"h												8	
C18	Round foam pouf	156 Young Adult, 185 Youth Services	SixInch	Bubble pouf with Flexplus coating	Light blue (qty 3), Metallic Space (qty 3), Purple (qty 3), Silver (qty 5 for YS, qty 10 for YA)	18"ø x 18"h							10					14	

SKOKIE PUBLIC LIBRARY
 FURNITURE SCHEDULE
 ISSUED FOR BID
 DATE: 11.06.2019

ANDREW BERMAN ARCHITECT

Key	Furniture Type	Location	Mfr	Model	Finishes	Dimension	Lead Time (wk)	Estimated delivery date:			May 2020			Oct 2020			Feb 2021		
								Phase 1: 2nd floor			Phase 2: 1st fl West Side			Phase 3: 1st fl East Side					
								Unit Cost	Qty	Extended Cost	Unit Cost	Qty	Extended Cost	Unit Cost	Qty	Extended Cost			
C19A	Animal foam pouf	185 Youth Services	SixInch	Animals, Elephant	Turquoise													1	
C19B	Animal foam pouf	185 Youth Services	SixInch	Animals, Bear	Grape													1	
C19C	Animal foam pouf	185 Youth Services	SixInch	Animals, Cat	Green													1	
C19D	Animal foam pouf	185 Youth Services	SixInch	Animals, Dog	Light Blue													1	
C19E	Animal foam pouf	185 Youth Services	SixInch	Animals, Pig	Pink													1	
C19F	Animal foam pouf	185 Youth Services	SixInch	Animals, Duck	Yellow													1	
C19G	Animal foam pouf	185 Youth Services	SixInch	Animals, Shark	Orange													1	
C20	Upholstered Pouf, small	109 Street East, 126 Reading Room, 209 East Seating	Arper	Pix 67	Spradling Valencia, Silver	26 3/8"dia x 17"h							3					3	
C21	Upholstered Pouf, medium	186 Storytelling, 102 East Lobby, 109 Street East, 126 Reading Room	Arper	Pix 87	Spradling Valencia, Silver	34"dia x 17"h			4				2					3	
C22	Upholstered Pouf, large	102 East Lobby	Arper	Pix 137	Spradling Valencia, Silver	53 7/8"dia x 17 3/8"h												1	
C23	Lounge chair	126 Reading Room, 176 Family Room, 193 Nursing Room, 185 Youth Services, 2nd floor East seating	Artifort	Beso Lounge chair - 4 wood legs	Upholstery: Ultrafabrics Promessa Camel Legs: Natural oak NK				20				3					7	
C24	Swivel Lounge chair	206 North seating, 244 Reading Room	Andreu World	Alya low back lounge chair BU-1523 - swivel 4-star aluminum base, self-return system	Upholstery: Spradling Dolce Tangelo Legs: Polished aluminum	28.25"w x 28.25" d x 31.5"h x 17"h seat			24				2						
C25	Club chair	Reading room, 210 South Seating	Sandler Seating	Lund 6.1 armchair	Upholstery: Spectrum vinyl Light Grey Frame: Epoxy black				16				20						
C26	not used																		
C27A	Existing nesting chair	146 Book Discussion Room	KI	Existing Torsion Air Nesting Chairs, to have seat reupholstered	Upholstery: Umbel Luggage VULG								44						
C27B	Existing nesting armchair	146 Book discussion room	KI	Existing Torsion Air Nesting Armchairs, to have seat reupholstered	Upholstery: Umbel Luggage VULG								11						
C28	Bench sofa with back	122 Cafe	Allemeir	Axyl bench, short AXLB16 - wood shell, cast aluminum frame and legs	Seat: Oak veneer, clear Frame: white powdercoat	63"w x 25.75" x 17.25"h seat							4						
C29	2-seater sofa	176 Family Room, 193 Nursing Room	Dauphin	Reefs 2 seater sofa RF0642 - wood legs	Upholstery: Maharam Lariat Auburn Legs: Natural oak													2	
C30	3-seater sofa	209 East Seating	Davis	A-Bench 3 seater sofa AB-123-PA - aluminum legs - provide (2) Byrne Minitap duplex outlets, daisy chained, undermounted, with 6' plug cord - provide Byrne cable clips as required	Upholstery: Ultrafabrics Promessa Bronze Legs: Polished aluminum	85 5/8"w x 25 5/8" x 32"h x 18 3/4"h seat			8										
C31	Upholstered 3-seater backless bench		Davis	A-Bench 3 seater backless bench AB-103-PA - aluminum legs	Upholstery: Ultrafabrics Promessa Bronze Legs: Polished aluminum	76 7/8" x 21 1/4" d x 18 3/4"h							6						
C32	Upholstered 4-seater backless bench		Davis	A-Bench 4 straight module backless bench - (4) Backless seat cushion AB-1000 - (2) End leg, black, AB-10-PC - (1) Connector leg, black AB-11-PC - (2) two seat beam AB-22	Upholstery: Ultrafabrics Promessa Bronze Legs: Polished aluminum				1										

Key	Furniture Type	Location	Mfr	Model	Finishes	Dimension	Lead Time (wk)	May 2020			Oct 2020			Feb 2021			
								Unit Cost	Qty	Extended Cost	Unit Cost	Qty	Extended Cost	Unit Cost	Qty	Extended Cost	
																	Phase 1: 2nd floor
C33	L-shaped modular lounge seating	209 East Seating	Davis	A-Bench - (2) Straight cushion AB-1001 - (1) Arm cushion, left AB-1002-L - (1) Arm cushion, right AB-1002-R - (1) Corner cushion AB-1003 - (2) End leg, black, AB-10-PC - (2) Connector leg, black AB-11-PC - (2) two seat beam AB-22 - (1) corner beam - provide (2) Byrne Minitap duplex outlets, daisy chained, undermounted, with 6' plug cord - provide Byrne cable clips as required	Upholstery: Ultrafabrics Promessa Bronze Legs: Polished aluminum				4								
C34	Modular lounge seating, East lobby	102 East Lobby	Davis	A-Bench - (5) Straight cushion AB-1001 - (1) Arm cushion, left AB-1002-L - (1) Arm cushion, right AB-1002-R - (2) End leg, black, AB-10-PC - (2) Connector leg, black AB-11-PC - (2) two seat beam AB-22 - (1) three seat beam AB-23	Upholstery: Ultrafabrics Promessa Bronze Legs: Polished aluminum											1	
C35	Modular lounge seating, West lobby	145 Waiting Area	Davis	A-Bench - (2) Straight cushion AB-1001 - (1) Arm cushion, right AB-1002-R - (2) End leg, black, AB-10-PC - (1) three seat beam AB-23	Upholstery: Ultrafabrics Promessa Bronze Legs: Polished aluminum							1					
C36A	Modular lounge seating, circular, facing in and out, piece 1	113 Street South	Davis	A-Bench - (2) Inside curve AB-2000 - (1) Outside curve AB-2001 - (1) Backless curve AB-2002 - (2) End leg, black, AB-10-PC - (1) Connector leg, black AB-11-PC - (2) Radius beam AB-25 - provide (2) Byrne Minitap duplex outlets, daisy chained, undermounted, with 6' plug cord - provide Byrne cable clips as required	Upholstery: Ultrafabrics Promessa Bronze Legs: Polished aluminum							1					
C36B	Modular lounge seating, circular, facing in and out, piece 2	113 Street South	Davis	A-Bench - (3) Outside curve AB-2001 - (1) Backless curve AB-2002 - (2) End leg, black, AB-10-PC - (1) Connector leg, black AB-11-PC - (2) Radius beam AB-25 - provide (2) Byrne Minitap duplex outlets, daisy chained, undermounted, with 6' plug cord - provide Byrne cable clips as required	Upholstery: Ultrafabrics Promessa Bronze Legs: Polished aluminum							1					
C36C	Modular lounge seating, circular, facing in and out, piece 3	113 Street South	Davis	A-Bench - (3) Inside curve AB-2000 - (1) Backless curve AB-2002 - (2) End leg, black, AB-10-PC - (1) Connector leg, black AB-11-PC - (2) Radius beam AB-25 - provide (2) Byrne Minitap duplex outlets, daisy chained, undermounted, with 6' plug cord - provide Byrne cable clips as required	Upholstery: Ultrafabrics Promessa Bronze Legs: Polished aluminum							1					
C37	Modular lounge seating, circular, facing in	162 Street north	Davis	A-Bench - (4) Inside curve AB-2000 - (2) End leg, black, AB-10-PC - (1) Connector leg, black AB-11-PC - (2) Radius beam AB-25 - provide (2) Byrne Minitap duplex outlets, daisy chained, undermounted, with 6' plug cord - provide Byrne cable clips as required	Upholstery: Ultrafabrics Promessa Bronze Legs: Polished aluminum							1					

SKOKIE PUBLIC LIBRARY
 FURNITURE SCHEDULE
 ISSUED FOR BID
 DATE: 11.06.2019

ANDREW BERMAN ARCHITECT

						Estimated delivery date:			May 2020			Oct 2020			Feb 2021				
Key	Furniture Type	Location	Mfr	Model	Finishes	Dimension	Lead Time (wk)	Phase 1: 2nd floor			Phase 2: 1st fl West Side			Phase 3: 1st fl East Side					
								Unit Cost	Qty	Extended Cost	Unit Cost	Qty	Extended Cost	Unit Cost	Qty	Extended Cost			
C38	Modular lounge seating, serpentine	113 Street South	Davis	A-Bench - (2) Inside curve AB-2000 - (2) Outside curve AB-2001 - (2) Backless curve AB-2002 - (2) Curved finished surface AB-3002 - (2) End leg, black, AB-10-PC - (3) Connector leg, black AB-11-PC - (4) Radius beam AB-25 - provide (2) Byrne Minitap duplex outlets, daisy chained, undermounted, with 6' plug cord - provide Byrne cable clips as required	Upholstery: Ultrafabrics Promessa Bronze Legs: Polished aluminum							1							
C39A	Modular lounge seating, serpentine	185 Youth Services by North courtyard	Davis	A-Bench - (5) Inside curve AB-2000 - (3) Backless curve AB-2002 - (2) End leg, black, AB-10-PC - (3) Connector leg, black AB-11-PC - (4) Radius beam AB-25 - provide (3) Byrne Minitap duplex outlets, daisy chained, undermounted, with 6' plug cord - provide Byrne cable clips as required	Upholstery: Ultrafabrics Promessa Bronze Legs: Polished aluminum												1		
C39B	Modular lounge seating, serpentine	185 Youth Services by North courtyard	Davis	A-Bench - (5) Inside curve AB-2000 - (3) Backless curve AB-2002 - (2) End leg, black, AB-10-PC - (3) Connector leg, black AB-11-PC - (4) Radius beam AB-25 - provide (3) Byrne Minitap duplex outlets, daisy chained, undermounted, with 6' plug cord - provide Byrne cable clips as required	Upholstery: Ultrafabrics Promessa Bronze Legs: Polished aluminum													1	
C40	Bench seating, Kids Play area	185 Youth Services play area	SixInch	Trinity - (10) Trinity 3, no back	Flexplus coating (5) Ultramarine, (5) Purple													1	
C41	YS central modular seating, cluster 1	185 Youth Services	SixInch	Trinity - (3) Trinity 1, straight back - (1) Trinity 3, no back	Flexplus coating Trinity 1: (1) Light blue, (2) Metallic Silver Trinity 3: (1) Purple													1	
C42	YS central modular seating, cluster 2	185 Youth Services	SixInch	Trinity - (3) Trinity 1, straight back - (1) Trinity 3, no back	Flexplus coating Trinity 1: (1) Metallic Space, (2) Purple Trinity 3: (1) Silver													1	
C43	YS central modular seating, cluster 3	185 Youth Services	SixInch	Trinity - (6) Trinity 1, straight back - (2) Trinity 3, no back	Flexplus coating Trinity 1: (2) Metallic Space, (2) Silver, (1) Purple, (1) Light blue Trinity 3: (1) Space, (1) Silver													1	
C44	YS central modular seating, cluster 4	185 Youth Services	SixInch	Trinity - (6) Trinity 1, straight back - (2) Trinity 3, no back	Flexplus coating Trinity 1: (3) Metallic Space, (1) Silver, (1) Purple, (1) Light blue Trinity 3: (1) Light blue, (1) Purple													1	
C45	YS modular seating for graphic novels	185 Youth Services	SixInch	Trinity - (8) Trinity 1, straight back	Flexplus coating Trinity 1: (4) Metallic Space, (4) Purple													1	
C46	Teen modular lounge seating, cluster 1	185 Youth Services	SixInch	Trinity - (2) Trinity 1, straight back - (1) Trinity 3, no back	Flexplus coating Trinity 1: (1) Metallic Space, (1) Light Blue Trinity 3: (1) Metallic Space							1							

SKOKIE PUBLIC LIBRARY
FURNITURE SCHEDULE
ISSUED FOR BID
DATE: 11.06.2019

ANDREW BERMAN ARCHITECT

								Estimated delivery date:			May 2020			Oct 2020			Feb 2021		
Key	Furniture Type	Location	Mfr	Model	Finishes	Dimension	Lead Time (wk)	Phase 1: 2nd floor			Phase 2: 1st fl West Side			Phase 3: 1st fl East Side					
								Unit Cost	Qty	Extended Cost	Unit Cost	Qty	Extended Cost	Unit Cost	Qty	Extended Cost			
C47	Teen modular lounge seating, cluster 2	185 Youth Services	SixInch	Trinity - (3) Trinity 1, straight back - (2) Trinity 3, no back	Flexplus coating Trinity 1: (1) Metallic Space, (2) Light blue Trinity 3: (2) Metallic Space							1							
C48	Teen modular lounge seating, cluster 3	185 Youth Services	SixInch	Trinity - (2) Trinity 1, straight back - (2) Trinity 2, corner back - (2) Trinity 3, no back	Flexplus coating Trinity 1: (1) Metallic Space, (2) Light blue Trinity 2: (2) Metallic Space Trinity 3: (2) Light blue							1							
C49	Pouf lounge chair, existing	158 Gaming	Niemkamper	Blob lounge chair, existing to be reupholstered	Side panels: Maharam Lariat Black 006 Front and Back panels: Maharam Lariat Pepper 030							2							
C50	Pouf 3 seater sofa	158 Gaming	Niemkamper	Blob 3 seater	Side panels: Maharam Lariat Black 006 Front and Back panels: Maharam Lariat Pepper 030							1							
C51	Exterior wood bench	169 N. Courtyard	Streetlife	Rough and Ready Curve Bench R&R-C-575-60 - 180° - refer to plan for layout	Seat: standard Louro Gamela Hardwood Base: standard galvanized steel	12'-0" custom outer diameter, 20"d seat										2			
C52	Exterior wood bench	124 South Courtyard	Streetlife	Rough and Ready Curve Bench R&R-C-1448-60 - 310° - refer to plan for layout	Seat: standard Louro Gamela Hardwood Base: standard galvanized steel	5m outer diameter, 24"d seat						1							

TABLES

T1A	Exterior table, square, color 1	169 N. Courtyard, 124 South Courtyard	Fermob	Luxembourg 4-legged table 4135 - no parasol hole	29 Verveine/Verbena	31.5" x 31.5" x 29"h						3				2	
T1B	Exterior table, square, color 2	124 South Courtyard	Fermob	Luxembourg 4-legged table 4135 - no parasol hole	38 Gris metal/Steel grey	31.5" x 31.5" x 29"h						8					
T1C	Exterior table, square, pedestal style	3rd floor staff terrace	Fermob	Luxembourg pedestal table 4134 - no parasol hole	29 Verveine/Verbena	31.5" x 31.5" x 29"h			4								
T2	Exterior low table	124 South Courtyard	Fermob	Luxembourg small low table 4160	29 Verveine/Verbena	17" x 16.5" x 15.7"h						3					
T3	Laptop table	156 Young Adult, 209 East Seating	Davis	Poise PE-2500-AY-MW		21 5/8" w x 15 3/4" d x 26"h			10			5					
T4	Occasional round table, 30" ø	145 Waiting Area and 102 East Lobby, 185 Youth Services, 209 East Seating	Keilhauer	Juxta Table 47231 - Straight Laminate Edge with Corresponding Laminate Edge Band LSC	Top: matte white laminate, Bianco Kos Lam61 Legs: Polished Aluminum PA00	30"ø x 15"h			10			1				6	
T5	Occasional round table, 30" ø, powered	126 Reading Room, 208 North Seating, 210 South Seating, 209 East Seating, 244 Reading Room	Keilhauer	Juxta Table 47231 - Straight Laminate Edge with Corresponding Laminate Edge Band LSC - Centered duplex electrical outlet PA2A	Top: matte white laminate, Bianco Kos Lam61 Legs: Polished Aluminum PA00	30"ø x 15"h			14			6				2	
T6	not used																
T7	Occasional round table, 48" ø	Street	Davis	Inform occasional table IF-1548-R-ML-FX - Metal legs	Top: matte white laminate, Fenix Bianco Kos Legs: matte white metal	48"ø x 15"h						2					
T8	Occasional round table, 60" ø	185 Youth Services	Davis	Inform custom occasional table XIF-2060-R-ML-FX - Metal legs	Top: matte white laminate, Fenix Bianco Kos Legs: matte white metal	60"ø x 15"h										1	
T9	Work round table, 36"ø	Staff offices, 156 Young Adult, CW rooms	Keilhauer	Juxta Table 47243 - Straight Laminate Edge with Corresponding Laminate Edge Band LSC	Top: matte white laminate, Bianco Kos Lam61 Legs: Polished Aluminum PA00	36"ø x 29"h			4			6					

Key	Furniture Type	Location	Mfr	Model	Finishes	Dimension	Lead Time (wk)	Estimated delivery date:			May 2020			Oct 2020			Feb 2021		
								Phase 1: 2nd floor			Phase 2: 1st fl West Side			Phase 3: 1st fl East Side					
								Unit Cost	Qty	Extended Cost	Unit Cost	Qty	Extended Cost	Unit Cost	Qty	Extended Cost			
T10	Work square table, 36"x 36"	122 Cafe, 191 Returns	Keilhauer	Juxta Table 47143 - Straight Laminate Edge with Corresponding Laminate Edge Band LSC	Top: matte white laminate, Bianco Kos Lam61 Legs: Polished Aluminum PA00	36" x 36" x 29"h						12							
T11	Work round table, 42"ø	185 Youth Services, YS CW rooms	Keilhauer	Juxta Table 47253 - Straight Laminate Edge with Corresponding Laminate Edge Band LSC	Top: matte white laminate, Bianco Kos Lam61 Legs: Polished Aluminum PA00	42"ø x 29"h											6		
T12	Work round table, 48"ø, powered	CW rooms	Keilhauer	Juxta Table 47263 - Straight Laminate Edge with Corresponding Laminate Edge Band LSC - Centered duplex electrical outlet PA2A	Top: matte white laminate, Bianco Kos Lam61 Legs: Polished Aluminum PA00	48"ø x 29"h			10										
T13	Work round table, 60"ø	158 Gaming	Davis	Inform meeting table IF-2060-R-ML-FX - Metal legs	Top: matte white laminate, Fenix Bianco Kos Legs: matte white metal	60"ø x 29.5"h						1							
T14	Work oval table, 72"ø, powered	CW rooms	Keilhauer	Juxta Table 47553 - Straight Laminate Edge with Corresponding Laminate Edge Band LSC - (2) duplex electrical outlets PA2A, centered on each half of the table - Custom rounded corners with 15" radius	Top: matte white laminate, Bianco Kos Lam61 Legs: Polished Aluminum PA00	42" x 72" x 29"h			4								1		
T15	Bar height round table, 48"ø	Street, 211 Business Center	Davis	Inform bar table IF-4048-R-ML-FX - Metal legs	Top: matte white laminate, Fenix Bianco Kos Legs: matte white metal	48"ø x 42"h			2			2							
T16	Bar height round table, 60"ø	Street	Davis	Inform meeting table IF-4060-R-ML-FX - Metal legs	Top: matte white laminate, Fenix Bianco Kos Legs: matte white metal	60"ø x 42"h						1							
T17	Bar height rectangular table	211 Business Center	Davis	Inform meeting table IF-43720-R-ML-FX - Metal legs - custom height 34" (approved by Davis)	Top: matte white laminate, Fenix Bianco Kos Legs: matte white metal	36" x 72" x 34"h			1										
T18	Butcherblock table, 24" x 66"	166 Boombox	3Branch	Maker Table MK-6624ADJ-BBK - adjustable height legs on casters with brake - (1) Byrne Mho duplex flipup outlets, with 10' plug cord BE01820-M-2-0-EFA-120 - undercounter wire management clips	Top: 1 1/2" thick solid maple fixed top Legs: brushed stainless steel	24" x 66" x 29-41"h											12		
T19	Butcherblock table, 30" x 84"	218 Makerspace	3Branch	Maker Table MK-8430ADJ-BBK - adjustable height legs on casters with brake - (1) Byrne Mho duplex flipup outlets, with 10' plug cord BE01820-M-2-0-EFA-120 - undercounter wire management clips	Top: 1 1/2" thick solid maple fixed top Legs: brushed stainless steel	30" x 84" x 29-41"h			16										
T20	Butcherblock table, 42" x 120"	156 YS	3Branch	Maker Table MK-12042ADJ-BBK - adjustable height legs on casters with brake - stretcher support - (2) Byrne M2X back-to-back duplex flipup outlets, daisy chained, with 10' plug cord BE01820-M2X-2-0-EFA-120 - undercounter wire management clips	Top: 1 1/2" thick solid maple fixed top Legs: brushed stainless steel	42" x 120" x 29-41"h						2							
T21	Butcherblock flip top table, 36" x 60"	107 Pantry	3Branch	Maker Flex Nesting Flip top Adjustable Table MF-603636-NEST-FIXT-BBK-CAS - height adjustable legs on casters with brake	Top: 1 1/2" thick solid maple fixed top Legs: brushed stainless steel	36" x 60" x 27-41"h											2		
T22	Flitop table, 30" x 72"	146 Book Discussion Room	KI	Pirouette nesting rectangular training Table (to match existing) PINR3060T-74P-NNN-FMP-4EC - casters - fabric modesty panel	Top and edge: laminate Monticello Maple LMT Legs: chrome CH	30" x 72" x 29"h						3							
T23	Flitop table, powered, 36" x 60"	211 Business Center	KI	Pirouette nesting rectangular training Table with Activ8 PANR3660T-74P-VUU-NMP-4EC - casters - provide total of (6) Activ8 power infeed and (8) jumper cables for these tables	Top and edge: laminate Frosty white LFW Legs: chrome CH	36" x 60" x 29"h			12										

SKOKIE PUBLIC LIBRARY
 FURNITURE SCHEDULE
 ISSUED FOR BID
 DATE: 11.06.2019

ANDREW BERMAN ARCHITECT

Key	Furniture Type	Location	Mfr	Model	Finishes	Dimension	Lead Time (wk)	May 2020			Oct 2020			Feb 2021					
								Unit Cost	Qty	Extended Cost	Phase 1: 2nd floor			Phase 2: 1st fl West Side			Phase 3: 1st fl East Side		
											Unit Cost	Qty	Extended Cost	Unit Cost	Qty	Extended Cost	Unit Cost	Qty	Extended Cost
T24	Fliptop table, 36" x 72"	188 Classroom	KI	Pirouette nesting rectangular training Table PINR3672T-74P-NNN-NMP-4EC - casters	Top and edge: laminate Grey LGE Legs: chrome CH	36" x 72" x 29"h										12			
T25	Adjustable Height Table, 30" x 48"	222 Computer Commons	Herman Miller	Renew rectangular table with C-foot DU6ACS3048LE-SUD-91-91-91-PSC - cutout and provide (1) 2.5"ø grommet kit FV982-91, centered to table and 2" away from the edge of the long side of table	Top and edge: laminate white 91 Legs: white 91	30" x 48" x 27" -46"h			3										
T26	Adjustable Height Table, 30" x 66"	222 Computer Commons	Herman Miller	Renew rectangular table with C-foot DU6ACS3066LE-SUD-91-91-91-PSC - cutout and provide (1) 2.5"ø grommet kit FV982-91, centered to table and 2" away from the edge of the long side of table	Top and edge: laminate white 91 Legs: white 91	30" x 66" x 27" -46"h			1										
T27	Adjustable Height Table, 30" x 72"	191 Returns	Herman Miller	Renew rectangular table with C-foot DU6ACS3072LE-SUD-91-91-91-PSC - cutout and provide (1) 2.5"ø grommet kit FV982-91, centered to table and 2" away from the edge of the long side of table	Top and edge: laminate white 91 Legs: white 91	30" x 72" x 27" -46"h					2								
T28	Adjustable Height Table, 30" x 84"	191 Returns	Herman Miller	Renew rectangular table with C-foot DU6ACS3084LE-SUD-91-91-91-PSC - cutout and provide (1) 2.5"ø grommet kit FV982-91, centered to table and 2" away from the edge of the long side of table	Top and edge: laminate white 91 Legs: white 91	30" x 84" x 27" -46"h					1								
T29	CW work table, 30" x 46"	247 Studio 2	Herman Miller	Everywhere table DT1A-S-30-48-LP-91-91-91 - 4 post legs - cutout and provide (1) 2.5"ø grommet kit FV982-91, centered to table and 2" away from the edge of the long side of table - length to be cut to fit field dimension	Top and edge: laminate white 91 Legs: white 91	30" x 46" (v.i.f.) x 29.5"h			1										
T30	CW work table, 30" x 54"	245 Studio 1	Herman Miller	Everywhere table DT1A-S-30-54-LP-91-91-91 - 4 post legs - cutout and provide (1) 2.5"ø grommet kit FV982-91, centered to table and 2" away from the edge of the long side of table - length to be cut to fit field dimension	Top and edge: laminate white 91 Legs: white 91	30" x 54" x 29.5" h			3										
T31	CW work table, 30" x 72"	180 CW, 181 CW, 182 CW	Herman Miller	Everywhere table DT1A-S-30-72-LP-91-91-91-NTG - 4 post legs	Top and edge: laminate white 91 Legs: white 91	30" x 72" x 29.5" h										3			
T32	CW work table, 30" x 84"	248 Studio 3	Herman Miller	Everywhere table DT1A-S-30-84-LP-91-91-91-NTG - (4) post legs, with (1) central support leg - cutouts and provide (2) 2.5"ø grommet kits FV982-91, centered to each half of the table, 2" away from the edge of long side of table	Top and edge: laminate white 91 Legs: white 91	30" x 84" x 29.5" h			1										
T33	CW work table, 24" x 72"	228-233 CW rooms	Herman Miller	Layout Studio table - Rectangular work surface GNTRN-2472-GL-91 - Engage legs (2) GNLF-EL/ER-24-91 - Stiffener FV696-81	Top and edge: laminate white 91 Legs: white 91	24" x 72" x 29.5" h			6										
T34	Rectangular standing height table, 48" x 84"	172 Y.S. Office	Herman Miller	Layout Studio table, standing height - Project table GNTPA-48-84-F-L-91-91-91 - Engage legs (2) GNLSN48-91 - intermediate leg GNLSN48-91 - beams GNBR - double wire management tray GNWD - cutouts and provide (2) Logic grommet with 3 simplex receptacles and 10' plug cord Y1425EA-10-91 - umbilical riser GNWG-B-91	Top and edge: laminate white 91 Legs: white 91	48" x 84" x 41.5" h										1			

SKOKIE PUBLIC LIBRARY
 FURNITURE SCHEDULE
 ISSUED FOR BID
 DATE: 11.06.2019

ANDREW BERMAN ARCHITECT

Estimated delivery date:								May 2020			Oct 2020			Feb 2021			
Key	Furniture Type	Location	Mfr	Model	Finishes	Dimension	Lead Time (wk)	Phase 1: 2nd floor			Phase 2: 1st fl West Side			Phase 3: 1st fl East Side			
								Unit Cost	Qty	Extended Cost	Unit Cost	Qty	Extended Cost	Unit Cost	Qty	Extended Cost	
T35	Rectangular meeting table, 48" x 96"	CE meeting room	Herman Miller	Layout Studio table - Project table GNTPA-48-96-FL-91-91 - Engage legs (2) GNLFEN48-91 - intermediate leg GNLFNSN - beams GNBR - double wire management tray GNWD - cutouts and provide (2) Logic grommet with 3 simplex receptacles and 6' plug cord Y1425EA-06-91 - umbilical riser GNWF-G-91	Top and edge: laminate white 91 Legs: white 91	48" x 96" x 29"h						1					
T36	Rectangular reading table, 60" x 120"	150 Meeting Room	Herman Miller	Layout Studio table - (3) Project table surfaces 48" x 60" GNTPA-48-60-FL-91-91 - Engage legs (2) GNLFEN60-91 - intermediate legs (2) GNLFNSN - beams GNBR - double wire management tray GNWD - cutouts and provide (3) Logic grommets with 3 simplex receptacles and 10' plug cord Y1425EA-10-91 - umbilical riser GNWF-G-91	Top and edge: laminate white 91 Legs: white 91	60" x 120" x 29"h											
T37	Rectangular reading table, 60" x 16'-0"	209 East Seating	Herman Miller	Layout Studio table - (2) Project table surfaces 60" x 96" GNTPA-60-96-FL-91-91 - Engage legs (2) GNLFEN60-91 - intermediate legs (3) GNLFNSN - beams GNBR - double wire management tray GNWD - cutouts and provide Logic grommets with 3 simplex receptacles and plug cord: (2) Y1425EA-06-91 and (2) Y1425EA-10-91 - umbilical riser GNWF-G-91	Top and edge: laminate white 91 Legs: white 91	60" x 192" x 29"h											
T38	Rectangular reading table, 60" x 21'-0"	244 Reading Room	Herman Miller	Layout Studio table - (3) Project table surfaces 60" x 84" GNTPA-60-84-FL-EU - Engage legs (2) GNLFEN60-91 - intermediate legs (5) GNLFNSN - beams GNBR - double wire management tray GNWD - cutouts and provide Logic grommets with 3 simplex receptacles with plug cord: (4) Y1425EA-10-91, (2) Y1425EA-20-91 - umbilical riser GNWF-G-91	Top and edge: Oak on Ash wood veneer EU Legs: white 91	60" x 252" x 29"h											
T39	Rectangular reading carrel table, 60" x 16'-0"	209 East Seating	Herman Miller	Layout Studio table - (4) Project table surfaces 30" x 96" GNTRD-30-96-FL-91-91 - Engage legs (2) GNLFEN60-91 - intermediate legs (3) GNLFNSN - beams GNBR - double wire management tray GNWD - floor power entry cover in center GNPCR-91 - (8) access door GNPDA-91 - (4) double junction block attachment bracket GNPAD - (4) back to back 1 duplex junction block - power entry - junction block jumpers as required - Desk up laminate screens (4) GNSDL-46-48-91-91-91 - End of run laminate screens (2) 46"h, 60"w, white 91 (Specials approved by Herman Miller Options) - Delineation framed screen with laminate in lieu of tackable fabric (custom), (6) GNSPN-46-30-91-91	Top and edge: laminate white 91 Legs: white 91 Screens: laminate white 91	60" x 192" x 29"h											

SKOKIE PUBLIC LIBRARY
 FURNITURE SCHEDULE
 ISSUED FOR BID
 DATE: 11.06.2019

ANDREW BERMAN ARCHITECT

Key	Furniture Type	Location	Mfr	Model	Finishes	Dimension	Lead Time (wk)	Estimated delivery date:			Feb 2021					
								May 2020	Oct 2020	Phase 1: 2nd floor	Phase 2: 1st fl West Side	Phase 3: 1st fl East Side				
								Unit Cost	Qty	Extended Cost	Unit Cost	Qty	Extended Cost	Unit Cost	Qty	Extended Cost
T40	Rectangular staff work table, 60" x 11'-0", with bookcase	153 CE Office 3	Herman Miller	Layout Studio table - (4) work surfaces 30" x 66" GNTRD-30-66-FL-91-91 - Engage legs (2) GNLFEN60-91 - intermediate legs (1) GNLFNSN - beams GNBR - double wire management tray GNWD - floor power entry cover in center GNPCR-91 - (4) access door GNPD-91 - (2) double junction block attachment bracket GNPAD - (2) back to back 2 duplexes junction block - power entry - junction block jumper - Desk up framed screens (2) GNSDN-46-66-91 - End of Run Bookcase, aligned with tabletop, L2ER.B-28-60-1-0-L-8-91	Top and edge: laminate white 91 Legs: white 91 Screens: Ground Cloth, Vapor Grey 4701	60" x 132"					1					

STAFF WORK DESKS

S1	Staff freestanding work desk, 96"	163 Lab	Herman Miller	Canvas Office Landscape Private Office - Rectangular work surface FTS102496-LS-91-91 - Stiffener FV696 - cable management trough FT199 - Closed support legs FV2E2S24FL-91 - cutouts and provide (1) 2.5"ø grommet kit FV982-91, centered to table and 2" away from the edge of the long side of table - umbilical riser GNWF-G-91 - full height laminate modesty panel, flush with table edge FV697-96-F-L-91 - Tu fixed pedestal cabinet LW100-20-BBF-SR-SS-91-KC-1F-3M	Top: laminate white 91 Legs: laminate white 91 Modesty panel: laminate white 91	24" x 96" x 29"h					1					
S2	Staff work desk for 3, 17'-10" long	130 Book Mobile Office	Herman Miller	Canvas Office Landscape Wall - Rectangular work surface (3) FTS103072-LS-91-91. Cut length of far left work surface to fit field verified dimension ±5'-9". - Rectangular work surface, 20"d FTS102060-LS-91-91 - Stiffener (1) FV696-48, (2) FV696-57 - cable management trough (4) FT199 - Closed end support leg FV2E2S-30-FL-91 - Support post leg at back corner FV689-91 - Shared open support leg FV2A2-2A-F-S - Support post legs (2) FV689.P-91, for 20"d surface - for each work surface, provide cutout and provide (1) 2.5"ø grommet kit FV982-91, centered to table and 2" away from the edge of the long side of table - Tu surface-attached pedestal (2) LW140-28-BBF-SR-SS-91-KC-2F-3M - Tackboard (1) FV980WM24-66-R, (2) FV980WM24-72-R - Cast LED light (3) FV617-4N - Overhead storage cabinet with hinged doors (1) FV43HWM22-66-LWTLKC-91, (2) FV43HWM22-72-LWTLKC-91	Top: laminate white 91 Legs: laminate white 91 Tackboard and Screens: Ground Cloth, Vapor Grey 4701	17'-10"w x 29"h				1						

Key	Furniture Type	Location	Mfr	Model	Finishes	Dimension	Lead Time (wk)	Estimated delivery date:			Phase 1: 2nd floor			Phase 2: 1st fl West Side			Phase 3: 1st fl East Side		
								May 2020	Oct 2020	Feb 2021	Unit Cost	Qty	Extended Cost	Unit Cost	Qty	Extended Cost	Unit Cost	Qty	Extended Cost
S3	Staff work desk without overhead cabinet, 11'-9" long	131 Call Center west wall	Herman Miller	Canvas Office Landscape Wall - Rectangular work surface (2) FTS103072-LS-91-91. Cut length of work surface on east side to fit field dimension ±5'-9". - Stiffener (1) FV696-62, (1) FV696-67 - cable management trough (2) FT199 - Closed end support legs (2) FV2E2S-30-FL-91 - Open shared support leg FV2A2-2B-F-S - for each work surface, provide cutout and provide (1) 2.5"ø grommet kit FV982-91, centered to table and 2" away from the edge of the long side of table - Tu Credenza open with box file L2CD.BF-48-16-1-BD-L-02-U-M	Top: laminate white 91 Legs: laminate white 91	11'-9"w x 30"d						1							
S4	Staff work stations without overhead cabinet, 11'-9" long	131 Call Center east wall	Herman Miller	Canvas Office Landscape Wall - Rectangular work surface (2) FTS103072-LS-91-91. Cut length of work surface on east side to fit field verified dimension ±5'-9". - Stiffener (1) FV696-71, (1) FV696-67 - cable management trough (2) FT199 - Closed end support legs (2) FV2E2S30FL-91 - Open shared support leg FV2A2-2B-F-S - for each work surface, provide cutout and provide (1) 2.5"ø grommet kit FV982-91, centered to table and 2" away from the edge of the long side of table - Tu Credenza open with box file L2CD.BF-48-16-1-BC-L-02-U-M	Top: laminate white 91 Legs: laminate white 91	11'-9"w x 30"d						1							
S5	Staff private office, 7'w x 8'd	135 Office	Herman Miller	Canvas Office Landscape Wall - Rectangular work surface FTS103084-LS-91-91 - Rectangular work surface FTS102466-LS-91-91 - Stiffener (2) FV696-62 - Cable management trough (2) FT199 - Closed end support legs (2) FV2E2S-30-FL-91, FV2E2S-24-FL-91 - Open shared support leg FV2A2-2B-F-S - for each work surface, provide cutout and provide (1) 2.5"ø grommet kit FV982-91, centered to table and 2" away from the edge of the long side of table - Laminate modesty panel FV697-84-H-L-91 - Tu surface-attached pedestal LW140-28-BBF-SR-SS-91-KC-2F-3M - Tackboard (1) FV980WM24-30-R, (1) FV980WM24-66-R - Cast LED light (3) FV617-4N (install under 66" overhead cabinet) - Overhead storage cabinet with hinged doors (1) FV43HWM22-30-LWTLKC-91, (1) FV43HWM22-66-LWTLKC-91 - Provide attachment hardware for drywall as required	Top: laminate white 91 Legs: laminate white 91	7'w x 8'd						1							
S6	Staff work desk, 8'w	136 office west wall	Herman Miller	Canvas Office Landscape Wall - Rectangular work surface FTS103096-LS-91-91 - Stiffener FV696-81 - Cable management trough FT199 - Closed end support legs (2) FV2E2S30FL-91 - provide cutout and provide (1) 2.5"ø grommet kit FV982-91, centered to table and 2" away from the edge of the long side of table - Tu Credenza open with box file L2CD.BF-48-16-1-BD-L-02-U-M - Tackboard (2) FV980WM24-48-R - Cast LED light FV617-5N - Overhead storage cabinet with hinged doors (2) FV43HWM22-48-LWTLKC-91 - Provide attachment hardware for drywall as required	Top: laminate white 91 Legs: laminate white 91 Screens: Ground Cloth, Vapor Grey 4701	96" w x 30" d						1							

Key	Furniture Type	Location	Mfr	Model	Finishes	Dimension	Lead Time (wk)	Estimated delivery date:			Feb 2021											
								May 2020			Oct 2020			Phase 1: 2nd floor			Phase 2: 1st fl West Side			Phase 3: 1st fl East Side		
								Unit Cost	Qty	Extended Cost	Unit Cost	Qty	Extended Cost	Unit Cost	Qty	Extended Cost	Unit Cost	Qty	Extended Cost			
S7	Staff work desk, 8'w	136 office east wall, 137 office, 138 office	Herman Miller	Canvas Office Landscape Wall - Rectangular work surface FTS103096-LS-91-91 - Stiffener FV696-81 - Cable management trough FT199 - Closed end support legs (2) FV2E2S-30-FL-91 - provide cutout and provide (1) 2.5"ø grommet kit FV982-91, centered to table and 2" away from the edge of the long side of table - Tu Credenza open with box file L2CD.BF-48-16-1-BC-L-02-U-M - Tackboard (2) FV980WM24-48-R - Cast LED light FV617-5N - Overhead storage cabinet with hinged doors (2) FV43HWM22-48-LWTLKC-91 - Provide attachment hardware for drywall as required	Top: laminate white 91 Legs: laminate white 91 Screens: Ground Cloth, Vapor Grey 4701	96" w x 30" d							3									
S8	Staff work desk without overhead cabinet, 8'w	139 office	Herman Miller	Canvas Office Landscape Wall - Rectangular work surface FTS103096-LS-91-91 - Stiffener FV696-81 - Cable management trough FT199 - Closed end support legs (2) FV2E2S-30-FL-91 - provide cutout and provide (1) 2.5"ø grommet kit FV982-91, centered to table and 2" away from the edge of the long side of table - Tu Credenza open with box file L2CD.BF-48-16-1-BC-L-02-U-M - Tu surface-attached pedestal LW140-28-BBF-SR-SS-91-KC-2F-3M - Open shelf organizer FF900-24-29-L-AN, and attachment bracket FF902-29-91	Top: laminate white 91 Legs: laminate white 91	96" w x 30" d							1									
S9	Staff work desk, corner	191 Returns	Herman Miller	Canvas Office Landscape Wall - Rectangular work surface FTS103048-LS-91-91, length cut to fit field dimension ±3'-11" - Extended corner surface FTS23-7248-LS-91-91 - cable management trough FT199 - Closed end support legs (2) FV2E2S-30-FL-91 - Support post leg at back corner FV689-91 - Shared open support leg FV2A2-2B-F-S - for each work surface, provide cutout and provide (1) 2.5"ø grommet kit FV982-91, centered to table and 2" away from the edge of the long side of table	Top: laminate white 91 Legs: laminate white 91	72" w x 7'-11" d							1									
S10	Staff work desk for 8, 67'-6" long	191 Returns	Herman Miller	Canvas Office Landscape Wall - Rectangular work surface (9) FTS103090-LS-91-91 - Stiffener (6) FV696-67, (2) FV696-81 - cable management trough (8) FT199 - Closed end support legs (2) FV2E2S-30-FL-91 - Closed shared support legs (8) FV2E2S-2B-FL-91 - for each work surface, provide cutout and provide (1) 2.5"ø grommet kit FV982-91, centered to table and 2" away from the edge of the long side of table - Tu surface-attached pedestal (6) LW140-28-BBF-SR-SS-91-KC-2F-3M - Tackboard (6) FV980WM24-30-R, (6) FV980WM24-60-R - Framed screen, Delineation (7) CL/CR-46-30-R-91 (Specials approved by Herman Miller Options) - Cast LED light (6) FV617-5N - Overhead storage cabinet with hinged doors (6) FV43HWM22-30-LWTLKC-91, (6) FV43HWM22-60-LWTLKC-91	Top: laminate white 91 Legs: laminate white 91 Tackboard and Screens: Ground Cloth, Vapor Grey 4701	67'-6" w x 30" d							1									

		Estimated delivery date:			May 2020			Oct 2020			Feb 2021					
Key	Furniture Type	Location	Mfr	Model	Finishes	Dimension	Lead Time (wk)	Phase 1: 2nd floor			Phase 2: 1st fl West Side			Phase 3: 1st fl East Side		
								Unit Cost	Qty	Extended Cost	Unit Cost	Qty	Extended Cost	Unit Cost	Qty	Extended Cost
S11	Staff work stations for 3, 16'-6" long	153 CE office 3	Herman Miller	Canvas Office Landscape Wall - Rectangular work surface (3) FTS103066-LS-91-91 - cable management trough (3) FT199 - Closed end support legs (2) FV2E2S-30-FL-91 - Closed shared support legs (2) FV2E2S-2B-FL-91 - for each work surface, provide cutout and provide (1) 2.5"ø grommet kit FV982-91, centered to table and 2" away from the edge of the long side of table - Tu surface-attached pedestal (3) LW140-28-BBF-SR-SS-91-KC-2F-3M - Tackboard (3) FV980WM24-66-R - Cast LED light (3) FV617-4N - Overhead storage cabinet with hinged doors (3) FV43HWM22-66-LWTLKC-91 - Provide attachment hardware for drywall as required at South wall - Provide attachment hardware for brick wall as required at North wall	Top: laminate white 91 Legs: laminate white 91 Tackboard and Screens: Ground Cloth, Vapor Grey 4701	16'-6"w x 30"d					2					
S12	Staff private office, 8'w x 7'-6"d	151 CE office 1	Herman Miller	Canvas Office Landscape Wall - Rectangular work surface FTS103096-LS-91-91 - Rectangular work surface FTS103060-LS-91-91 - Stiffener FV696-81 - Cable management trough FT199 - Closed end support legs (2) FV2E2S-30-FL-91 - Shared open support leg FV2A2-2B-F-S - for each work surface, provide cutout and provide (1) 2.5"ø grommet kit FV982-91, 2" away from the edge of the long side of back table, 4" away from the edge of the long side of front table - Laminate modesty panel FV697-96-H-L-91 - Tu surface-attached pedestal (2) LW140-28-BBF-SR-SS-91-KC-2F-3M - Tackboard (1) FV980WM24-30-R, (1) FV980WM24-60-R - Cast LED light FV617-4N (install under 60" overhead cabinet) - Overhead storage cabinet with hinged doors (1) FV43HWM22-30-LWTLKC-91, (1) FV43HWM22-60-LWTLKC-91	Top: laminate white 91 Legs: laminate white 91 Tackboard: Ground Cloth, Vapor Grey 4701	8'w x 7'-6"d					1					
S13	Staff work desk for 3, 13'-11" long	149 volunteer room	Herman Miller	Canvas Office Landscape Wall - Rectangular work surface (2) FTS103060-LS-91-91 - Rectangular work surface (1) FTS103054-LS-91-91. Cut work surface to fit field verified dimension ±4'-3". - cable management trough (3) FT199 - Closed end support legs (2) FV2E2S-30-FL-91 - for each work surface, provide cutout and provide (1) 2.5"ø grommet kit FV982-91, centered to table and 2" away from the edge of the long side of table - Tu surface-attached pedestal (2) LW140-28-BBF-SR-SS-91-KC-2F-3M - Tackboard (1) FV980WM24-48-R, (2) FV980WM24-60-R - Cast LED light (3) FV617-3N - Overhead storage cabinet with hinged doors (1) FV43HWM22-48-LWTLKC-91, (2) FV43HWM22-60-LWTLKC-91 - Provide attachment hardware for drywall as required	Top: laminate white 91 Legs: laminate white 91 Tackboards: Ground Cloth, Vapor Grey 4701	16'-6"w x 30"d					1					

		Estimated delivery date:			May 2020			Oct 2020			Feb 2021						
Key	Furniture Type	Location	Mfr	Model	Finishes	Dimension	Lead Time (wk)	Phase 1: 2nd floor			Phase 2: 1st fl West Side			Phase 3: 1st fl East Side			
								Unit Cost	Qty	Extended Cost	Unit Cost	Qty	Extended Cost	Unit Cost	Qty	Extended Cost	
S14	Staff work desk for 2, 10'-9.5" long	194 YA office	Herman Miller	Canvas Office Landscape Wall - Rectangular work surface (2) FTS103066-LS-91-91. Cut work surface on the South side to fit field verified dimension ±5'-3.5". - cable management trough (1) FT199 - Stiffener (2) FV696-48 - Closed end support legs (2) FV2E2S-30-FL-91 - for each work surface, provide cutout and provide (1) 2.5"ø grommet kit FV982-91, centered to table and 2" away from the edge of the long side of table - Tu surface-attached pedestal (1) LW140-28-BBF-SR-SS-91-KC-2F-3M - Tackboard (1) FV980WM24-60-R, (1) FV980WM24-66-R - Cast LED light (2) FV617-4N - Overhead storage cabinet with hinged doors (1) FV43HWM22-60-LWTLKC-91, (1) FV43HWM22-66-LWTLKC-91 - Provide attachment hardware for drywall as required	Top: laminate white 91 Legs: laminate white 91 Tackboards: Ground Cloth, Vapor Grey 4701	10'-9.5" w x 30" d						1					
S15	Staff work desk for 2, 8'-10.5" long	172 YS office	Herman Miller	Canvas Office Landscape Wall - Rectangular work surface (2) FTS103054-LS-91-91. Cut work surface on the West side to fit field verified dimension ±4'-4.5". - cable management trough (1) FT199 - Closed end support legs (2) FV2E2S-30-FL-91 - for each work surface, provide cutout and provide (1) 2.5"ø grommet kit FV982-91, centered to table and 2" away from the edge of the long side of table - Tu surface-attached pedestal (1) LW140-28-BBF-SR-SS-91-KC-2F-3M - Tackboard (1) FV980WM24-48-R, (1) FV980WM24-54-R - Cast LED light (2) FV617-3N - Overhead storage cabinet with hinged doors (1) FV43HWM22-48-LWTLKC-91, (1) FV43HWM22-54-LWTLKC-91 - Provide attachment hardware for drywall as required	Top: laminate white 91 Legs: laminate white 91 Tackboards: Ground Cloth, Vapor Grey 4701	8'-10.5" w x 30" d						1					
S16	Staff work desk for 2, 9' long	251 staff	Herman Miller	Canvas Office Landscape Wall - Rectangular work surface (2) FTS103054-LS-91-91 - cable management trough (1) FT199 - Closed end support legs (1) FV2E2S-30-FL-91 - Open shared support leg (1) FV2A2-2B-F-S - for each work surface, provide cutout and provide (1) 2.5"ø grommet kit FV982-91, centered to table and 2" away from the edge of the long side of table - Tu surface-attached pedestal (2) LW140-28-BBF-SR-SS-91-KC-2F-3M - Tackboard (2) FV980WM24-54-R - Cast LED light (2) FV617-3N - Overhead storage cabinet with hinged doors (2) FV43HWM22-54-LWTLKC-91 - Provide attachment hardware for drywall as required	Top: laminate white 91 Legs: laminate white 91 Tackboards: Ground Cloth, Vapor Grey 4701	9' w x 30" d						1					

MISCELLANEOUS:

M1A	Mobile Whiteboard and Tackboard	156 Young Adult	Vitra	Dancing wall - wood base on casters - (2) whiteboard panels, (2) tackboards	Base: Spruce Frame: Black Tackboard: Plano TBD							2					
M1B	Mobile Whiteboard and Tackboard, for TV	156 Young Adult	Vitra	Dancing wall - wood base on casters - (2) whiteboard panels, (2) tackboards - provide cable tray and power outlets	Base: Spruce Frame: Black Tackboard: Plano TBD							1					
M1C	Mobile Whiteboard	211 Business Center	Vitra	Dancing wall - wood base on casters - (4) whiteboard panels	Base: Spruce Frame: Black												

		Estimated delivery date:		May 2020			Oct 2020			Feb 2021								
				Phase 1: 2nd floor			Phase 2: 1st fl West Side			Phase 3: 1st fl East Side								
Key	Furniture Type	Location	Mfr	Model	Finishes	Dimension	Lead Time (wk)	Unit Cost	Qty	Extended Cost	Unit Cost	Qty	Extended Cost	Unit Cost	Qty	Extended Cost		
M1D	Mobile Whiteboard, for TV	218 Makerspace, 211 Business Center	Vitra	Dancing wall - wood base on casters - (2) whiteboard panels - provide cable tray and power outlets	Base: Spruce Frame: Black				4									
M2	Adjustable height lecturn	166 Boombox, 211 Business Center	Haskell	Fuzion Sit to Stand - locking casters - grommet	Top: Wilsonart laminate Frosty White Matte Finish 1573-60 Leg: standard platinum paint finish	22" x 26" x 28 1/4" - 42"			1						1			
M3	Power outlet stand	156 YA	Steelcase	Thread Power Hub, lounge height - standard NEMA plug	4799 Platinum metallic	8"ø x 30"h						5						
M4	Glass top for existing Barcelona Table base	209 East Seating	custom	Clear tempered glass panel	Clear	44"ø x 3/4" thick			4									
M5	Open shelves cabinet	191 Returns	Herman Miller	Tu Storage Bookcase LG500-36-38-SS-91 - (2) metal shelves included	white 91	36"w x 15"d x 39 1/8"h						1						
M6	Desk height cabinet with doors	191 Returns	Herman Miller	Canvas Office Landscape Wood High Credenza with doors and top FF81K-42-20-LNTL-91-91 - lockable doors with bar pulls - center divider and (2) adjustable shelves included - (1) 42" w Thick top FF888-20-01-42-L-91	Laminate white 91	42"w x 20"d x 27 3/8"h						1						
M7	Tall cabinet, 30"w	153 CE office 3	Herman Miller	Canvas Office Landscape Wood Freestanding Bookcase FF54M7-30-4-2-BD-LLTL-91-91-91 - (4) adjustable shelves included - lockable doors with touch latch	Laminate white 91	30"w x 24"d x 68" h						4						
M8	Tall cabinet, 42"w	194 YA office	Herman Miller	Tu Bookcase L2BC-72-42-20-1-U-L-06-91-KC - center divider and 8 adjustable shelves - lockable doors with flush pull	Laminate white 91	42"w x 20"d x 72" h						1						
M9	Wardrobe	153 CE office 3	Herman Miller	Tu Wardrobe L2WR-72-36-24-1-L-06-91-KC	Laminate white 91	36"w x 24"d x 72" h						1						
M10	Gaming cabinet	158 Gaming	Herman Miller	Canvas Office Landscape Wood High Credenza, with doors and top (2) FF81K-36-20-LNTL-91-91 - lockable doors with bar pulls - (1) adjustable shelf included - (1) 72" w Thick top FF888-20-02-72-L-91 - for each credenza: for cable passthrough, custom cutout in back panel and provide (1) 2.5"ø grommet kit FV982-91, centered to back panel of credenza. for ventilation, custom cutouts in top panel and outside side panel and provide (2) sets of 4"ø air vent grommet Mockett ZGAVG2 and liner ZG1, white finish.	Laminate white 91	72"w x 20"d x 27 3/8"h									1			
M11A	Utility cart, with 2 shelves	218 Makerspace	Global Industrial	2 Shelf steel stock cart - 800 lb capacity	Standard painted grey steel	36"w x 24"d x 32" h			2									
M11B	Utility cart, with 3 shelves	218 Makerspace	Global Industrial	3 Shelf steel stock cart - 800 lb capacity	Standard painted grey steel	36"w x 24"d x 32" h			4									
Total Cost																		
Freight										\$ -			\$ -			\$ -		
Labor										\$ -			\$ -			\$ -		
Grand Total										\$ -			\$ -			\$ -		
Floor Area (SF)													30,271			30,454		24,546
Cost/ SF													\$0.00			\$0.00		\$0.00

3. See Exhibit B – Furniture Specifications, which is attached and incorporated by this reference. Bidder shall cause all furniture furnished, delivered and installed to meet and conform to the following specifications.

**EXHIBIT B – FURNITURE SPECIFICATIONS PREPARED
BY ANDREW BERMAN ARCHITECT DATED 11.6.19**

SKOKIE PUBLIC LIBRARY

**Furniture Specifications
Issued for Bid**

November 6 2019

Key	C1A
Furniture Type	Reading chair with wood legs
Location	2nd floor
Manufacturer	Vitra
Model	Hal Wood chair
Description	Wood legs, Plastic Shell
Finish/Color	Seat: 31 Warm grey, Legs: 10 Natural Oak
Dimension	
Notes	Available with seat pads, arms, casters, and stool base



Key	C1B
Furniture Type	Reading chair with wood legs
Location	122 Cafe, 2nd floor
Manufacturer	Vitra
Model	Hal Wood chair
Description	Wood legs, Plastic Shell
Finish/Color	Seat: 65 Orange, Legs: 10 Natural Oak
Dimension	
Notes	Available with seat pads, arms, casters, and stool base



Orange

Key	C2
Furniture Type	Reading armchair with seat pad
Location	Reading room, 2nd floor
Manufacturer	Vitra
Model	Hal Wood chair, with seat pad
Description	Wood legs, Plastic Shell, Seat Pad
Finish/Color	Seat: Warm grey, Legs: 10 Natural Oak, Seat pad upholstery: Pallas Nappa Mulberry
Dimension	
Notes	



Warm grey

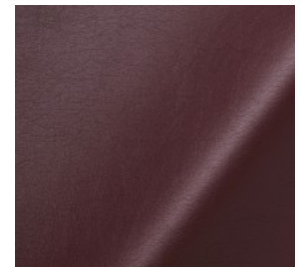

Pallas Nappa Mulberry

Key C2 add/alt
Furniture Type Reading armchair
Location 2nd floor reading room
Manufacturer Maruni
Model Hiroshima armchair high 2975-22
Description Wood shell with arms, no seat pad
Finish/Color Oak, clear urethane finish
Dimension
Notes



Key	C3A
Furniture Type	Reading chair with metal legs, color 1
Location	Staff offices
Manufacturer	Vitra
Model	Hal Tube Stackable chair
Description	Metal legs, Plastic Shell
Finish/Color	Seat: 31 warm grey, Legs: standard chrome, Glides: 30 basic dark
Dimension	
Notes	Stacks 6.



Warm grey

Key	C3B
Furniture Type	Reading chair with metal legs, color 2
Location	188 Classroom
Manufacturer	Vitra
Model	Hal Tube Stackable chair
Description	Metal legs, Plastic Shell
Finish/Color	Seat: 65 Orange, Legs: standard chrome, Glides: 30 basic dark
Dimension	
Notes	Stacks 6.



Orange

Key C4A
Furniture Type Chair with casters, color 1
Location 163 Lab, 170 YS entrance
Manufacturer Vitra
Model Hal Studio, adjustable height swivel base with casters
Description Plastic Shell, 5 casters
Finish/Color Seat: 31 Warm grey, Base: standard basic dark
Dimension
Notes



Warm grey

Key	C4B
Furniture Type	Chair with casters, color 2
Location	166 Boombox, 218 Makerspace, 222 Computer commons
Manufacturer	Vitra
Model	Hal Studio, adjustable height swivel base with casters
Description	Plastic Shell, 5 casters
Finish/Color	Seat: 65 Orange, Base: standard basic dark
Dimension	
Notes	



Key	C5
Furniture Type	Armchair with casters
Location	222 Computer commons
Manufacturer	Vitra
Model	Hal Armchair Studio, integral arms, adjustable height base with casters
Description	Plastic Shell, 5 casters
Finish/Color	Seat: 65 Orange, Base: standard basic dark
Dimension	
Notes	



Key C6
Furniture Type Counter stool
Location 166 Boombox, 218 Makerspace
Manufacturer Vitra
Model Hal Stool Medium
Description Plastic Shell, 4 metal legs, glides for hard floor
Finish/Color Seat: 65 Orange, Legs: standard chrome, Glides: 30 Basic dark
Dimension
Notes



Key C7A
Furniture Type Reading chair for Teen and Kids, color 1
Location 156 YA, 185 YS
Manufacturer Vitra
Model Tip Ton chair
Description
Finish/Color 37 Glacier blue
Dimension 20" w x 21 3/4" d x 31" h, 18 1/2" sh
Notes



Key C7B
Furniture Type Reading chair for Teen and Kids, color 2
Location 156 YA, 185 YS
Manufacturer Vitra
Model Tip Ton chair
Description
Finish/Color 78 Mango
Dimension 20" w x 21 3/4" d x 31" h, 18 1/2" sh
Notes



Key	C8
Furniture Type	Staff counter stool
Location	Help desk
Manufacturer	Allemuir
Model	Kin low back counter height stool
Description	Plastic Shell, 4 wood legs
Finish/Color	Seat: Aubergine, Legs: standard ash
Dimension	24.5" h seat, 30" h overall
Notes	



Key	C9
Furniture Type	Staff Office armchair with casters
Location	Staff offices
Manufacturer	Steelcase
Model	Think chair with arms 465A300
Description	Graphite
Finish/Color	Frame: 4799 Platinum metallic, Back: 3D Knit 5092 Graphite, Seat: 5S25 Graphite
Dimension	
Notes	



Key C10A
Furniture Type Stacking chair
Location 106 MR Room, 211 Business Center
Manufacturer KI
Model Opt4 Stacking Side Chair 04BSPB
Description stacks 38 high on dolly
Finish/Color Seat/Back: Black, solid poly, Base: chrome
Dimension 24 5/8" w x 21 13/16" x 32 3/16" h, 17 3/4" h seat
Notes



Key	C10B
Furniture Type	Stacking chair with arms
Location	106 MR Room, 211 Business Center
Manufacturer	KI
Model	Opt4 Stacking Side Chair 04LWAPSPB
Description	stacks 6 on floor
Finish/Color	Seat/Back: Black, solid poly, Base: chrome
Dimension	24 5/8" w x 21 13/16" x 32 3/16" h, 17 3/4" h seat
Notes	



Key C11
Furniture Type Stacking chair dolly
Location 106 MR Room, 211 Business Center
Manufacturer KI
Model Opt4 Dolly 04DA.BL
Description
Finish/Color standard
Dimension 22 3/8" w x 32" d x 16 3/4" h
Notes



Key C12A
Furniture Type Exterior chair, color 1
Location Cafe patio, courtyards
Manufacturer Fermob
Model Luxembourg side chair 4101
Description armless, stacks 10
Finish/Color 29 Verveine/ Verbena
Dimension 49cm w x 57cm d x 49cm h seat

Notes



Verbena

Key C12B
Furniture Type Exterior chair, color 2
Location Cafe patio, courtyards
Manufacturer Fermob
Model Luxembourg side chair 4101
Description armless, stacks 10
Finish/Color 38 Girs metal/ Steel grey
Dimension 49cm w x 57cm d x 49cm h seat

Notes



Steel grey

Key C12C
Furniture Type Exterior chair, steel
Location Staff terrace
Manufacturer Fermob
Model Luxembourg side chair in steel
Description armless, stacks 10
Finish/Color 29 Verveine/ Verbena
Dimension 49cm w x 57cm d x 49cm h seat

Notes

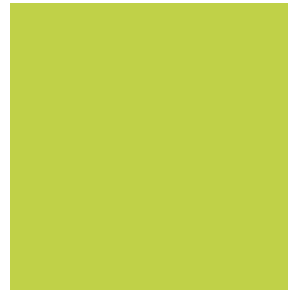

Verbena

Key C13
Furniture Type Exterior lounge chair
Location south courtyard
Manufacturer Fermob
Model Luxembourg side chair 4101
Description aluminum tube frame and slats, armrests
Finish/Color 29 Verveine/ Verbena
Dimension 70 cm x 86cm d x 40.5cm h seat

Notes



Verbena

Key C14
Furniture Type Exterior bench
Location south courtyard
Manufacturer Fermob
Model Luxembourg 3/4 seaters bench 4110
Description aluminum tube frame and slats
Finish/Color 29 Verveine/ Verbena
Dimension 145 cm w x 42.5 cm d x 48.8cm h seat
Notes



Verbena



Key	C15A
Furniture Type	Moveable stool for Teens, color 1
Location	156 YA
Manufacturer	Vitra
Model	Stool Tool
Description	stacks 10
Finish/Color	24 light grey
Dimension	14.25" w x 24.5" d x 29.5" h x 19" h seat
Notes	

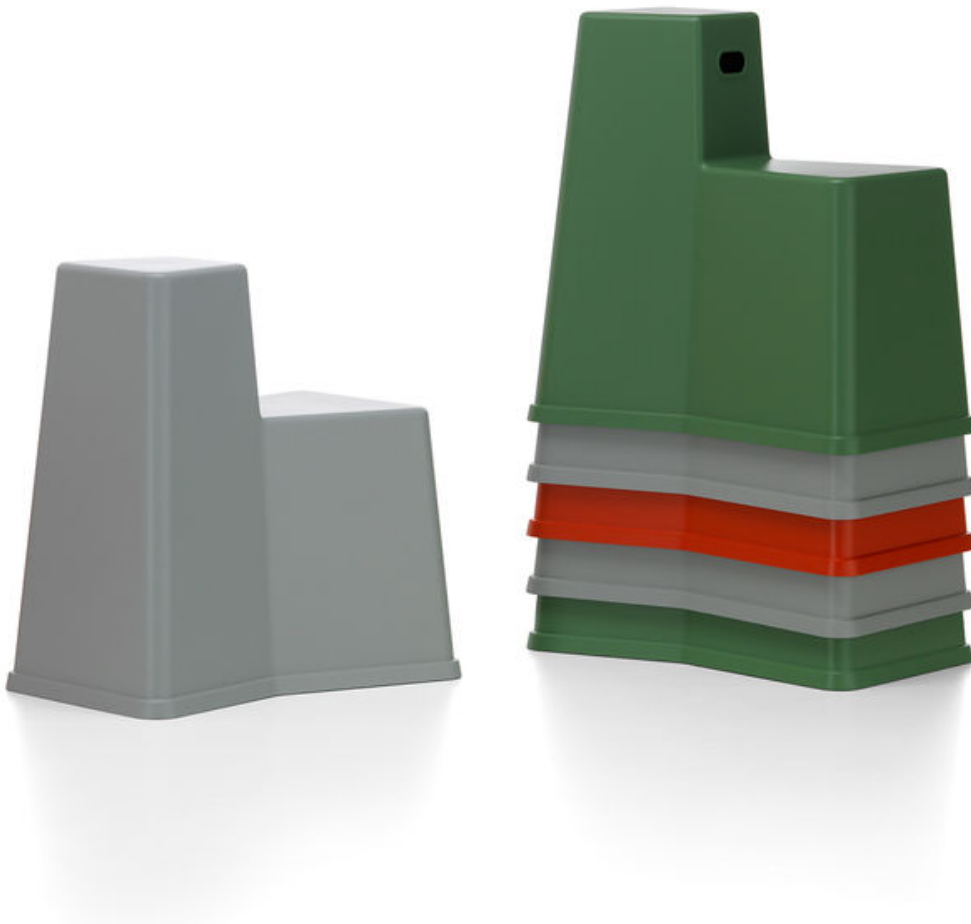

Key	C15B
Furniture Type	Moveable stool for Teens, color 2
Location	156 YA
Manufacturer	Vitra
Model	Stool Tool
Description	stacks 10
Finish/Color	76 industrial green
Dimension	14.25" w x 24.5" d x 29.5" h x 19" h seat
Notes	

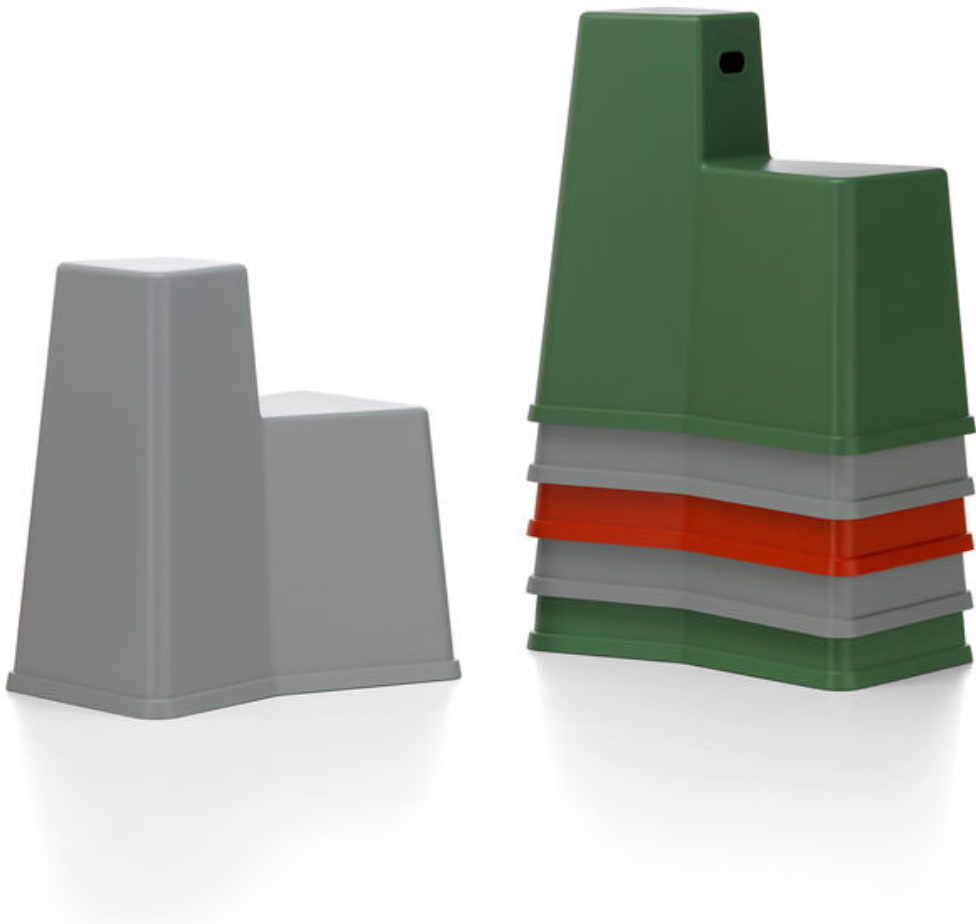

Key C16
Furniture Type Cushions for storytelling
Location 186 Storytelling
Manufacturer SixInch
Model Tingle cushion
Description Flexplus coating
Finish/Color
Dimension 5" thick, 13" dia.
Notes



Silver



Light Blue



Purple



Metallic Space

Key	C17
Furniture Type	Round foam pouf, low
Location	185 YS
Manufacturer	SixInch
Model	Bubble pouf with Flexplus coating
Description	Coated foam pouf
Finish/Color	FlexPlus coating
Dimension	18" dia., 12" h
Notes	

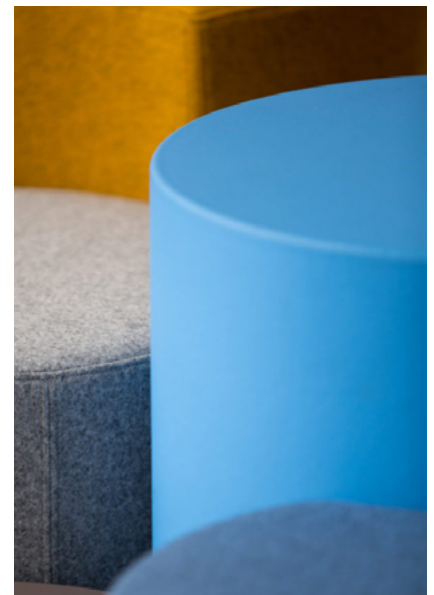

Silver



Light Blue



Purple



Metallic Space

Key	C18
Furniture Type	Round foam pouf
Location	156 YA, 185 YS
Manufacturer	SixInch
Model	Bubble pouf with Flexplus coating
Description	Coated foam pouf
Finish/Color	FlexPlus coating
Dimension	18" dia., 18" h
Notes	

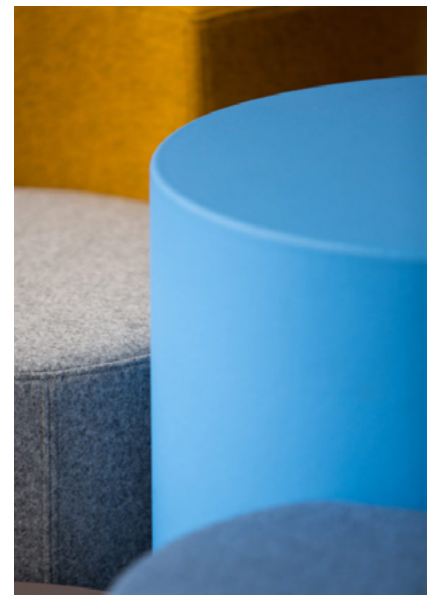

Silver



Light Blue



Purple



Metallic Space

Key C19A
Furniture Type Animal foam pouf
Location 185 YS
Manufacturer SixInch
Model Animals, Elephant
Description
Finish/Color Turquoise
Dimension
Notes



Key C19B
Furniture Type Animal foam pouf
Location 185 YS
Manufacturer SixInch
Model Animals, Bear
Description
Finish/Color Grape
Dimension
Notes



Key C19C
Furniture Type Animal foam pouf
Location 185 YS
Manufacturer SixInch
Model Animals, Cat
Description
Finish/Color Green
Dimension
Notes



Green



Key C19D
Furniture Type Animal foam pouf
Location 185 YS
Manufacturer SixInch
Model Animals, Dog
Description
Finish/Color Light Blue
Dimension
Notes



Light Blue



Key C19E
Furniture Type Animal foam pouf
Location 185 YS
Manufacturer SixInch
Model Animals, Pig
Description
Finish/Color Pink
Dimension
Notes

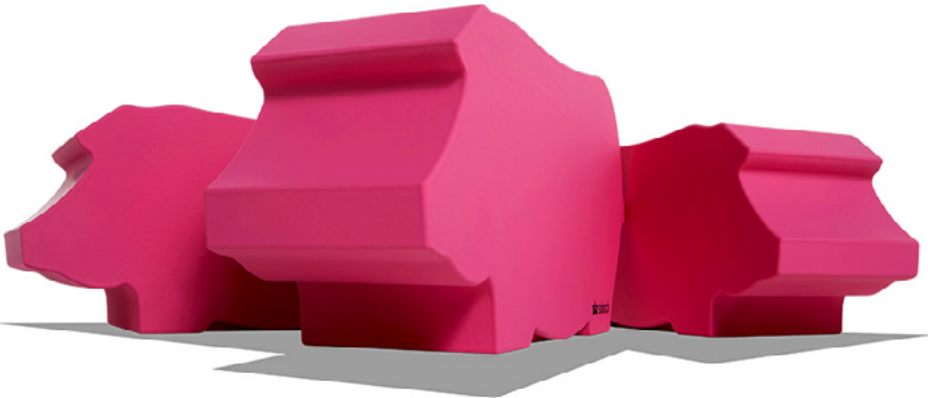

Key C19F
Furniture Type Animal foam pouf
Location 185 YS
Manufacturer SixInch
Model Animals, Duck
Description
Finish/Color Yellow
Dimension
Notes

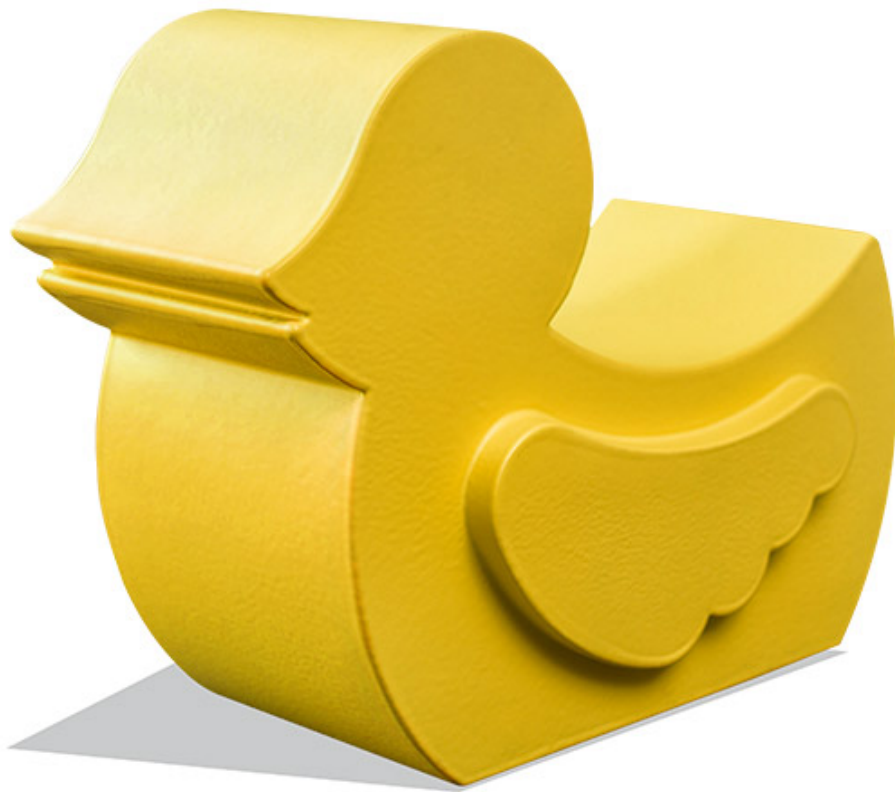

Key C19G
Furniture Type Animal foam pouf
Location 185 YS
Manufacturer SixInch
Model Animals, Shark
Description
Finish/Color Orange
Dimension
Notes



Orange

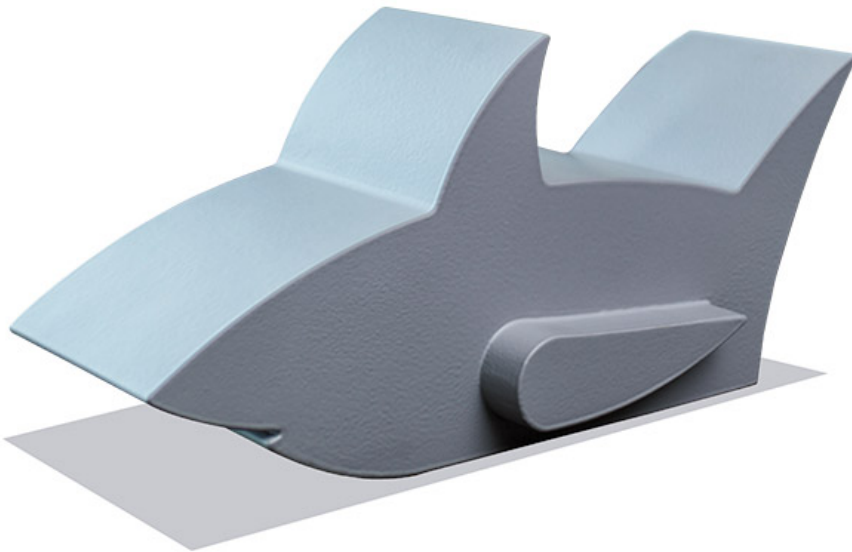

Key C20
Furniture Type Upholstered Pouf, small
Location
Manufacturer Arper
Model Pix 67
Description
Finish/Color Spradling Valencia, Silver
Dimension 26 3/8" dia x 17" h
Notes



Spradling Valencia, Silver



Key C21
Furniture Type Upholstered Pouf, medium
Location
Manufacturer Arper
Model Pix 87
Description
Finish/Color Spradling Valencia, Silver
Dimension 34" dia x 17" h
Notes



Spradling Valencia, Silver



Key C22
Furniture Type Upholstered Pouf, large
Location
Manufacturer Arper
Model Pix 137
Description
Finish/Color Spradling Valencia, Silver
Dimension 53 7/8" dia x 17" 3/8h
Notes



Spradling Valencia, Silver



Key	C23
Furniture Type	Lounge chair, color 1
Location	176 Family Room, 193 Nursing Room, 2nd floor East Seating
Manufacturer	Artifort
Model	Beso Lounge Chair
Description	4 wood legs
Finish/Color	Upholstery: Ultrafabrics Promess Camel, Wood legs: Natural Oak NK.
Dimension	
Notes	

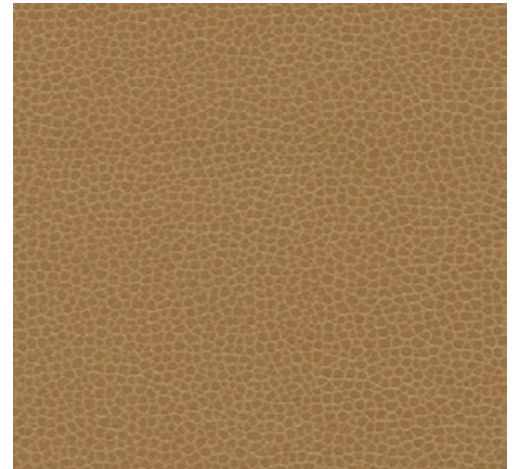

Ultrafabrics Promess Camel

Key C24
Furniture Type Swivel Lounge chair
Location 2nd floor North seating, 2nd floor Reading Room
Manufacturer Andreu World
Model Alya
Description Low back lounge chair BU-1523, swivel aluminum 4-star base
Finish/Color Upholstery: Spradling Dolce, Tangelo. Base: polished aluminum.
Dimension 28.25" w x 28.25" d 31.5" h x 17" h seat
Notes

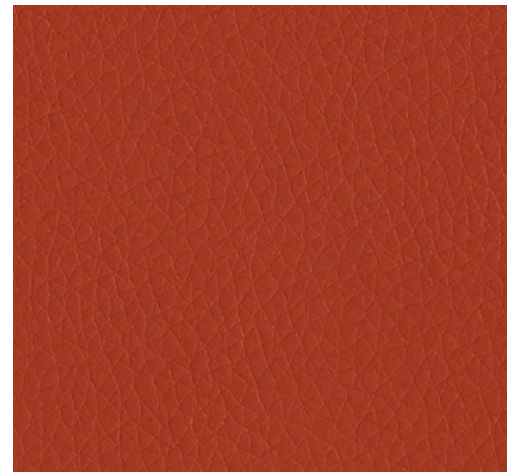

Dolce, Tangelo

Key	C25
Furniture Type	Club chair
Location	Reading room, 2nd floor South Seating
Manufacturer	Sandler Seating
Model	Lund 6.1
Description	Lounge chair with metal arms and legs
Finish/Color	Upholstery: Spectrum Vinyl, Light Grey. Frame: Epoxy black paint.
Dimension	16.9”h seat



Spectrum Vinyl, Light grey

Key C27A
Furniture Type Existing Nesting chair
Location 146 Book discussion room
Manufacturer KI
Model Torsion Air chair
Description Seat to be re-upholstered
Finish/Color
Dimension Upholstery: Umbel Luggabe VULG

Notes

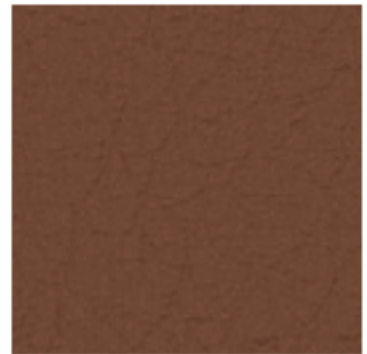

Umbel vinyl, Luggage

Key C27B
Furniture Type Existing Nesting Armchair
Location 146 Book discussion room
Manufacturer KI
Model Torsion Air chair
Description Seat to be re-upholstered
Finish/Color
Dimension Upholstery: Umbel Luggabe VULG

Notes



Umbel vinyl, Luggage

Key C28
Furniture Type Bench seating for Cafe
Location 122 Cafe
Manufacturer Allemuir
Model Axl Bench
Description Bench
Finish/Color Oak veneer seat and back, white painted frame
Dimension 63" w x 25.75" x 17.25" h seat

Notes

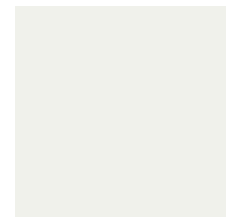

White frame



Key	C29
Furniture Type	2 seater sofa
Location	176 Family Room, 193 Nursing Room
Manufacturer	Dauphin
Model	Reefs 2 seater sofa
Description	Upholstered seat and backrest
Finish/Color	Upholstery: Maharam Lariat, Russet. Legs: Natural Oak.
Dimension	17.5”h seat
Notes	

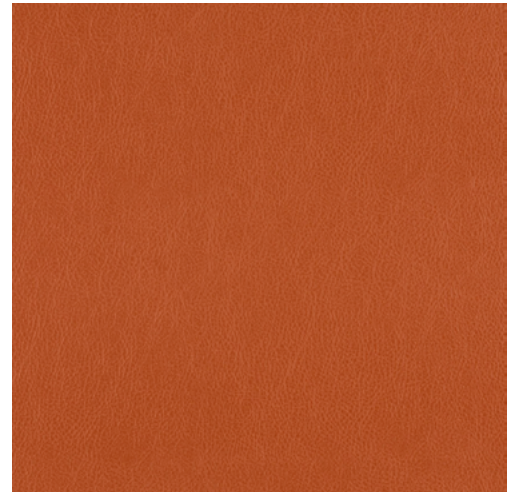

Maharam Lariat, Auburn



Key	C30
Furniture Type	3 seater sofa
Location	2nd floor East seating
Manufacturer	Davis
Model	A-Bench
Description	Modular sofa
Finish/Color	Ultrafabrics Promessa Bronze seat and back, polished aluminum legs
Dimension	85 5/8" w x 25 5/8" x 32" h x 18 3/4" h seat
Notes	Provide Byrne Minitap outlets, daisy chained, as indicated on dwgs.



Ultrafabrics Promessa Bronze

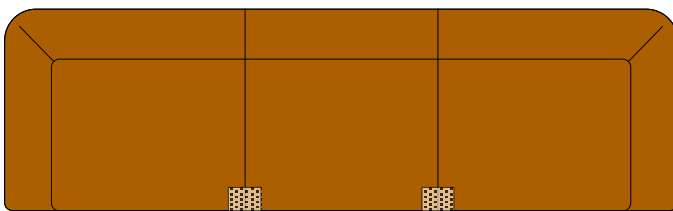

location of undermounted power outlet, typical for 2

Plan View
Not to scale

Key	C31
Furniture Type	Upholstered 3 seater backless bench
Location	
Manufacturer	Davis
Model	A-Bench
Description	Modular bench
Finish/Color	Ultrafabrics Promessa Bronze seat and back, polished aluminum legs
Dimension	76 7/8" x 21 1/4" d x 18 3/4" h
Notes	Refer to plan and schedule for details.

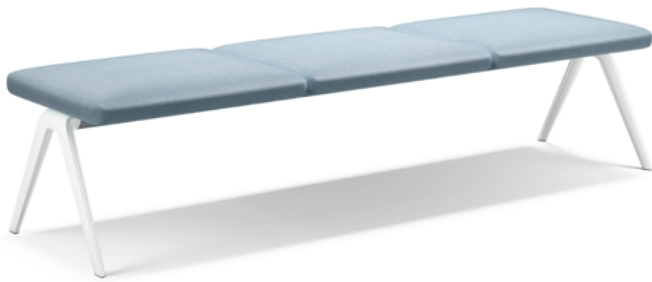

Ultrafabrics Promess Bronze

Key	C32
Furniture Type	Upholstered 4 seater backless bench
Location	
Manufacturer	Davis
Model	A-Bench
Description	Modular bench
Finish/Color	Ultrafabrics Promessa Bronze seat and back, polished aluminum legs
Dimension	
Notes	Refer to plan and schedule for details.

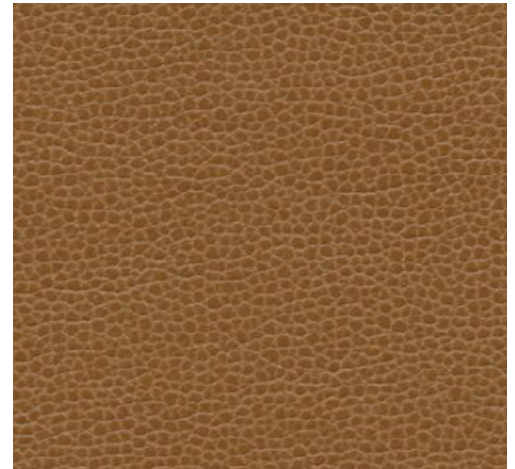
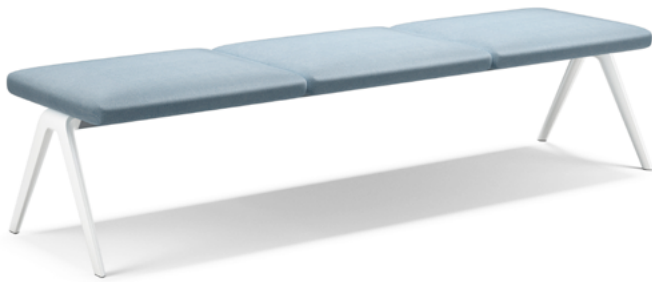

Ultrafabrics Promess Bronze

Key	C33
Furniture Type	L-shaped modular lounge seating
Location	2nd fl East Seating
Manufacturer	Davis
Model	A-Bench
Description	Modular sofa
Finish/Color	Ultrafabrics Promessa Bronze seat and back, polished aluminum legs
Dimension	
Notes	Provide Byrne Minitap outlets, daisy chained, as indicated on dwgs.



Ultrafabrics Promessa Bronze

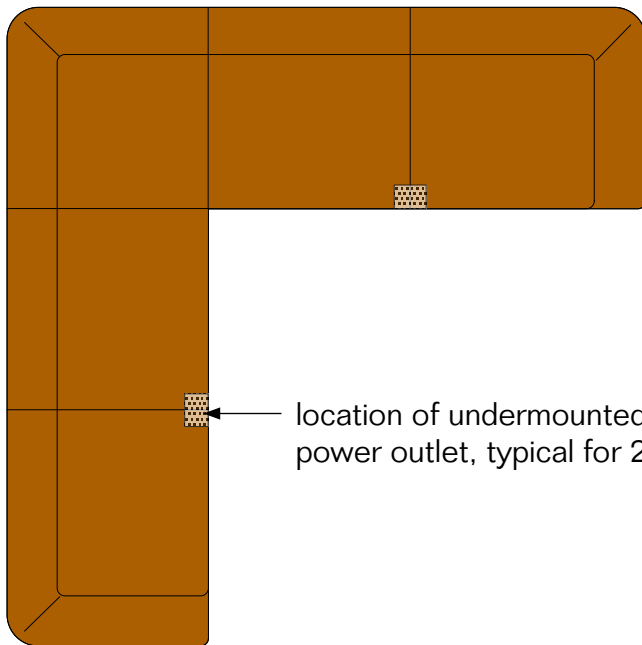

location of undermounted power outlet, typical for 2

Plan View
Not to scale



Key	C34
Furniture Type	Modular lounge seating, East lobby
Location	102 east lobby
Manufacturer	Davis
Model	A-Bench
Description	Modular sofa
Finish/Color	Ultrafabrics Promessa Bronze seat and back, polished aluminum legs
Dimension	
Notes	Refer to plan and schedule for details.



Ultrafabrics Promess Bronze

Key	C35
Furniture Type	Modular lounge seating, West lobby
Location	145 waiting area
Manufacturer	Davis
Model	A-Bench
Description	Modular sofa
Finish/Color	Ultrafabrics Promessa Bronze seat and back, polished aluminum legs
Dimension	
Notes	Refer to plan and schedule for details.



Ultrafabrics Promess Bronze

Key C36A, B, C

Furniture Type Modular lounge seating circular, facing in and out, pieces 1, 2 and 3

Location 113 Street south

Manufacturer Davis

Model A-Bench

Description Modular sofa

Finish/Color Ultrafabrics Promessa Bronze seat and back, polished aluminum legs

Dimension

Notes Provide Byrne Minitap outlets, daisy chained, as indicated on dwgs.



Ultrafabrics Promessa Bronze

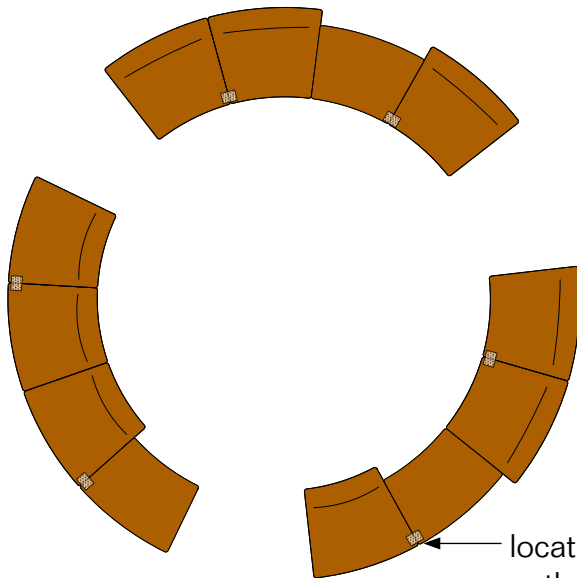

location of undermounted power outlet, typical for 2 at each piece

Plan View
Not to scale

Key	C37
Furniture Type	Modular lounge seating circular, facing in
Location	162 Street north
Manufacturer	Davis
Model	A-Bench
Description	
Finish/Color	Ultrafabrics Promessa Bronze seat and back, polished aluminum legs
Dimension	
Notes	Provide Byrne Minitap outlets, daisy chained, as indicated on dwgs.



Ultrafabrics Promess Bronze

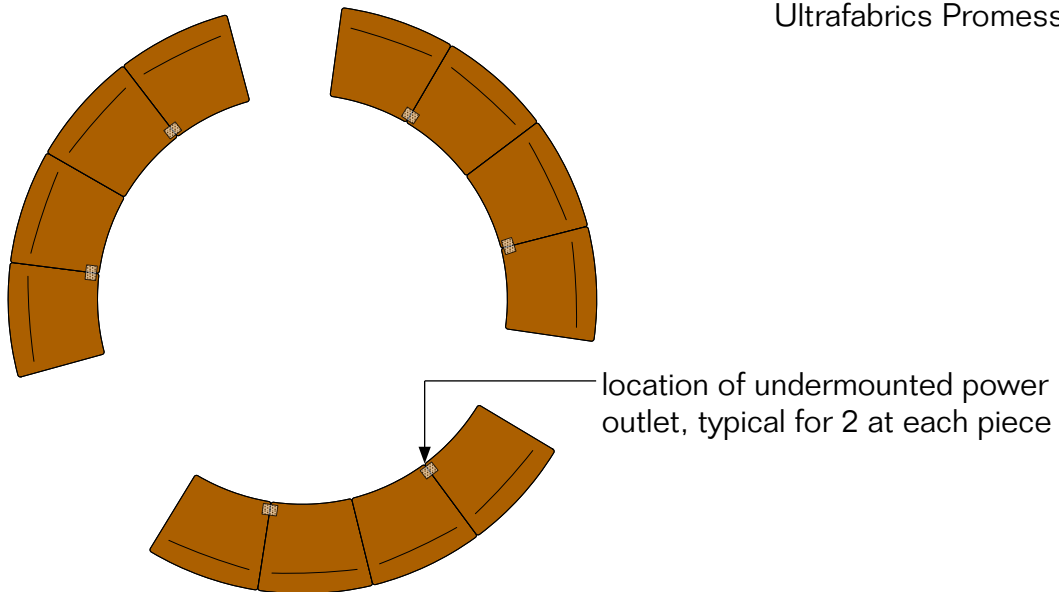

Plan View
Not to scale

Key C38

Furniture Type Modular lounge seating, serpentine

Location 113 Street south

Manufacturer Davis

Model A-Bench

Description

Finish/Color Ultrafabrics Promessa Bronze seat and back, polished aluminum legs

Dimension

Notes Provide Byrne Minitap outlets, daisy chained, as indicated on dwgs.



Ultrafabrics Promessa Bronze

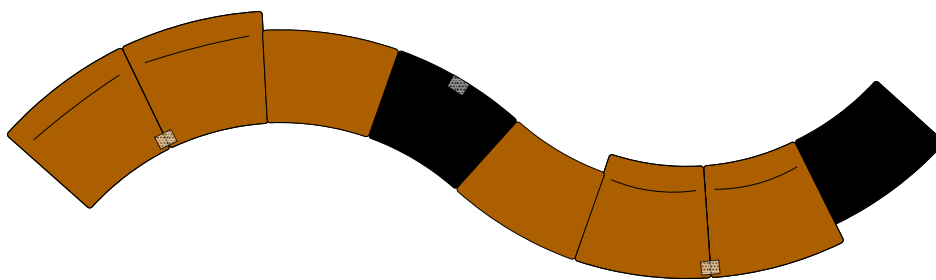

location of undermounted power outlet, typical for 2

Plan View
Not to scale

Key C39A
Furniture Type Modular lounge seating, serpentine
Location 185 YS by North Courtyard
Manufacturer Davis
Model A-Bench
Description
Finish/Color Ultrafabrics Peomessa Camel seat and back, polished aluminum legs
Dimension
Notes Provide Byrne Minitap outlets, daisy chained, as indicated on dwgs.



Ultrafabrics Promess Bronze

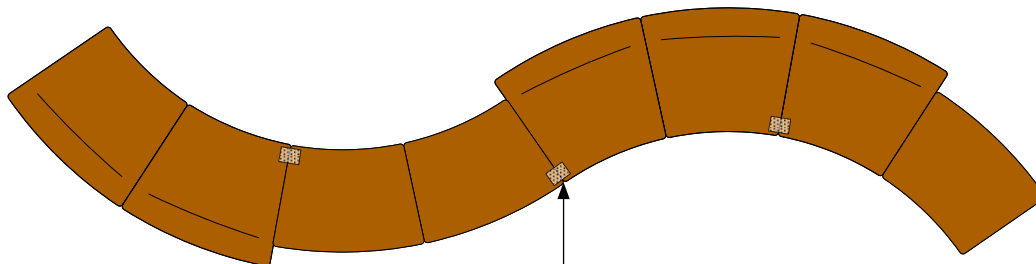

location of undermounted power outlet, typical for 3

Plan View
Not to scale

Key C39B
Furniture Type Modular lounge seating, serpentine
Location 185 YS by North Courtyard
Manufacturer Davis
Model A-Bench
Description
Finish/Color Ultrafabrics Promessa Bronze seat and back, polished aluminum legs
Dimension
Notes Provide Byrne Minitap outlets, daisy chained, as indicated on dwgs.



Ultrafabrics Promessa Bronze

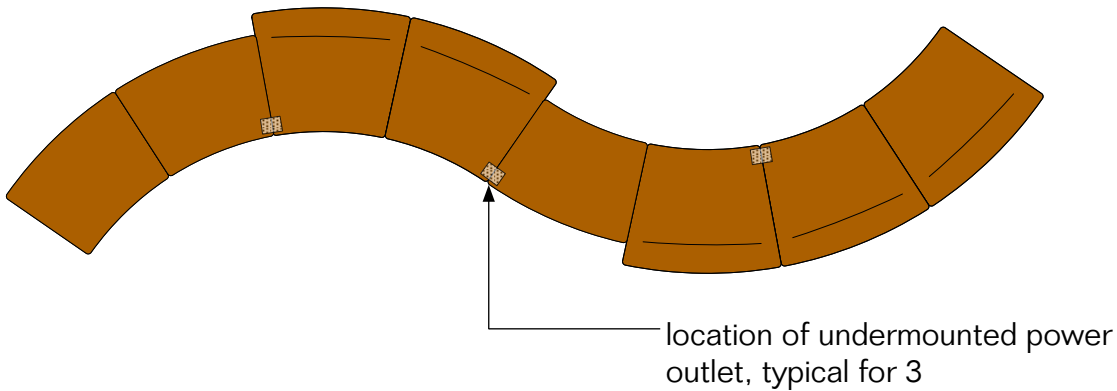

Plan View
Not to scale

Key	C40
Furniture Type	Bench setting, Kids play area
Location	185 YS play area
Manufacturer	SixInch
Model	Trinity
Description	no back
Finish/Color	FlexPlus coating. Refer to schedule and plan.
Dimension	15.5" h seat
Notes	



Silver



Light Blue



Purple



Metallic Space

Key	C41
Furniture Type	YS central modular seating, cluster 1
Location	185 YS
Manufacturer	SixInch
Model	Trinity
Description	straight & no back
Finish/Color	FlexPlus coating. Refer to schedule and plan.
Dimension	15.5" h seat
Notes	



Silver



Light Blue



Purple



Metallic Space

Key	C42
Furniture Type	YS central modular seating, cluster 2
Location	185 YS
Manufacturer	SixInch
Model	Trinity
Description	straight & no back
Finish/Color	FlexPlus coating. Refer to schedule and plan.
Dimension	15.5" h seat
Notes	



Silver



Light Blue



Purple



Metallic Space

Key	C43
Furniture Type	YS central modular seating, cluster 3
Location	185 YS
Manufacturer	SixInch
Model	Trinity
Description	straight & no back
Finish/Color	FlexPlus coating. Refer to schedule and plan.
Dimension	15.5" h seat
Notes	



Silver



Light Blue



Purple



Metallic Space

Key	C44
Furniture Type	YS central modular seating, cluster 4
Location	185 YS
Manufacturer	SixInch
Model	Trinity
Description	straight & no back
Finish/Color	FlexPlus coating. Refer to schedule and plan.
Dimension	15.5" h seat
Notes	



Silver



Light Blue



Purple



Metallic Space

Key	C45
Furniture Type	YS modular seating for graphic novels
Location	185 YS
Manufacturer	SixInch
Model	Trinity
Description	straight back
Finish/Color	FlexPlus coating. Refer to schedule and plan.
Dimension	15.5”h seat
Notes	



Purple



Metallic Space

Key	C46
Furniture Type	Teen modular lounge seating, cluset 1
Location	156 YA
Manufacturer	SixInch
Model	Trinity
Description	straight & no back
Finish/Color	FlexPlus coating. Refer to schedule and plan.
Dimension	15.5" h seat
Notes	



Light Blue



Metallic Space

Key	C47
Furniture Type	Teen modular lounge seating, cluster 2
Location	156 YA
Manufacturer	SixInch
Model	Trinity
Description	straight & no back
Finish/Color	FlexPlus coating. Refer to schedule and plan.
Dimension	15.5" h seat
Notes	



Light Blue



Metallic Space

Key	C48
Furniture Type	Teen modular lounge seating, cluster 3
Location	156 YA
Manufacturer	SixInch
Model	Trinity
Description	straight back, no back, corner back
Finish/Color	FlexPlus coating. Refer to schedule and plan.
Dimension	15.5" h seat
Notes	



Light Blue



Metallic Space

Key C49
Furniture Type Pouf lounge chair, existing
Location 158 Gaming
Manufacturer Nienkamper
Model Blob lounge chair
Description existing to be reupholstered
Finish/Color Maharam Lariat
Dimension 16" seat height

Notes

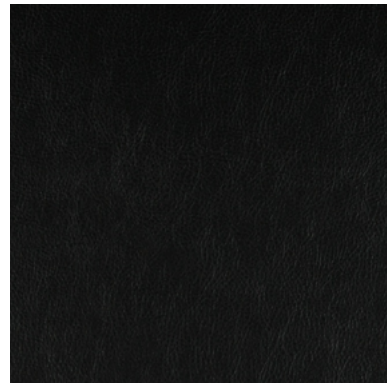

Maharam Lariat, Black 006



Maharam Lariat, Pepper 030



Key C50
Furniture Type Pouf 3 Seater
Location 158 Gaming
Manufacturer Nienkamper
Model Blob 3 seater
Description
Finish/Color Maharam Lariat
Dimension 16" seat height
Notes



Maharam Lariat, Black 006



Maharam Lariat, Pepper 030



Key	C51
Furniture Type	Exterior wood bench
Location	169 North Courtyard
Manufacturer	Streetlife
Model	Rough and Ready Curve Bench
Description	
Finish/Color	FSC-100% hardwood, galvanized steel base
Dimension	24" d, 17.7" h, (12' diameter North Courtyard, 15' diameter South Courtyard)
Notes	



Key	C52
Furniture Type	Exterior wood bench
Location	124 south courtyard
Manufacturer	Streetlife
Model	Rough and Ready Curve Bench
Description	
Finish/Color	FSC-100% hardwood, galvanized steel base
Dimension	24" d, 17.7" h, (12' diameter North Courtyard, 15' diameter South Courtyard)
Notes	



Key T1A
Furniture Type Exterior table, square, color 1
Location North and South Courtyard
Manufacturer Fermob
Model Luxembourg 4-legged table 4135
Description no parasol hole
Finish/Color 29 Verveine/ Verbena
Dimension
Notes



Key T1B
Furniture Type Exterior table, square, color 2
Location North and South Courtyard
Manufacturer Fermob
Model Luxembourg 4-legged table 4135
Description no parasol hole
Finish/Color 38 Gris metal/Steel grey
Dimension
Notes



Key T1C
Furniture Type Exterior table, square, pedestal
Location Staff terrace
Manufacturer Fermob
Model Luxembourg pedestal table 4134
Description no parasol hole
Finish/Color 29 Verveine/ Verbena
Dimension
Notes



Key T2
Furniture Type Exterior low table
Location South Courtyard
Manufacturer Fermob
Model Luxembourg small low table 4160
Description
Finish/Color 29 Verveine/ Verbena
Dimension
Notes



Key T3

Furniture Type Laptop table

Location Young adult, 2nd fl East seating

Manufacturer Davis

Model Poise PE-2500-AY-MW

Description

Finish/Color Metal base finish in matte white, Top in white Fenix Bianco Alaska.

Dimension 21 5/8" w x 15 3/4" d x 26" h

Notes



Key	T4
Furniture Type	Occasional table. 30"Ø
Location	West and East lobby, Youth services, 2nd fl East seating
Manufacturer	Keilhauer
Model	Juxta 47231
Description	
Finish/Color	Straight laminate edge with corresponding laminate edge band LSC
Dimension	30"Ø x 15"h
Notes	



Key T5
Furniture Type Occasional table. 30"Ø
Location Reading room. 2nd fl North , South, East seating, 2nd fl Reading Room
Manufacturer Keilhauer
Model Juxta 47231
Description
Finish/Color Straight laminate edge with corresponding laminate edge band LSC
Dimension 30"Ø x 15"h
Notes Centered duplex electrical outlet PA2A



Key T7
Furniture Type Occasional table. 48"Ø
Location Street
Manufacturer Davis
Model Inform occasional table 1F-1548-R-ML-FX
Description Metal legs
Finish/Color Top: matte white laminate, Fenix Bianco Kos, Legs: matte white metal
Dimension 48"Ø x 15"h

Notes

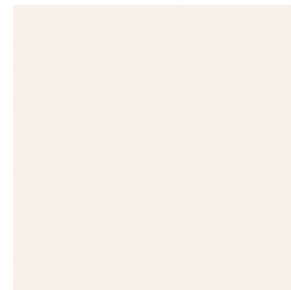

Fenix Bianco Kos

Key T8
Furniture Type Occasional table. 60"Ø
Location Youth Services
Manufacturer Davis
Model Inform custom occasional table XIF-2060-R-ML-FX
Description
Finish/Color Top: matte white laminate, Fenix Bianco Kos, Legs: matte white metal
Dimension 60"Ø x 15"h
Notes

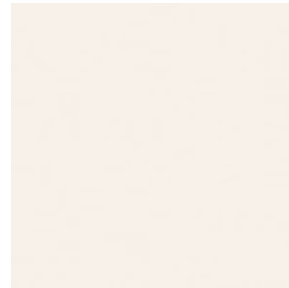

Fenix Bianco Kos

Key	T9
Furniture Type	Round work table, 36" ø
Location	Staff offices, Young adult, CW rooms
Manufacturer	Keilhauer
Model	Juxta Table 47243
Description	
Finish/Color	Top: matte white laminate, Bianco Kos Lam61, Legs: Polished Aluminum PA00
Dimension	36" ø x 29" h
Notes	



Key	T10
Furniture Type	Work square table, 36" x 36"
Location	Cafe, Returns
Manufacturer	Keilhauer
Model	Juxta Table 47143
Description	
Finish/Color	Top: matte white laminate, Bianco Kos Lam61, Legs: Polished Aluminum PA00
Dimension	36" x 36" x 29"h
Notes	

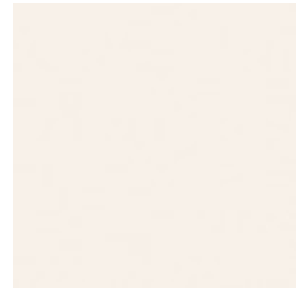

Fenix Bianco Kos



Key T11
Furniture Type Work round table, 42 ø
Location Youth Services, YS, CW room
Manufacturer Keilhauer
Model Juxta Table 47253
Description
Finish/Color Top: matte white laminate, Bianco Kos Lam 61, Legs: Polished Aluminum PA00
Dimension 42" ø x 29" h
Notes

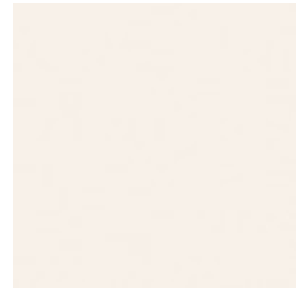

Fenix Bianco Kos

Key	T12
Furniture Type	Work round table, 48 ø
Location	CW rooms
Manufacturer	Keilhauer
Model	Juxta Table 47263
Description	
Finish/Color	Top: matte white laminate, Bianco Kos Lam 61, Legs: Polished Aluminum PA00
Dimension	48" ø x 29" h
Notes	Centered duplex electrical outlet PA2A

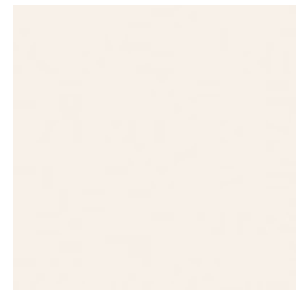

Fenix Bianco Kos



Key T13
Furniture Type Work round table, 60 ø
Location Young adult gaming
Manufacturer Davis
Model Inform meeting table 1F-2060-R-ML-FX
Description
Finish/Color Top: matte white laminate, Bianco Kos Lam 61, Legs: matte white metal
Dimension 60" ø x 29.5" h
Notes

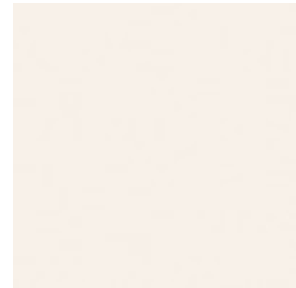

Fenix Bianco Kos

Key T13
Furniture Type Work round table, 60 ø
Location Young adult gaming
Manufacturer Davis
Model Inform meeting table 1F-2060-R-ML-FX
Description
Finish/Color Top: matte white laminate, Bianco Kos Lam 61, Legs: matte white metal
Dimension 60" ø x 29.5" h
Notes

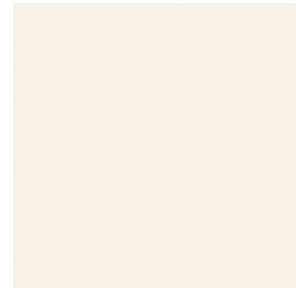

Fenix Bianco Kos

Key	T14
Furniture Type	Work oval table, 72 ø, powered
Location	CW rooms
Manufacturer	Keilhauer
Model	Juxta Table 47553
Description	Straight laminate edge with corresponding laminate edge band LSC.
Finish/Color	Top: matte white laminate, Bianco Kos Lam61. Legs: Polished Aluminum PA00
Dimension	42" x 72" x 29"h
Notes	(2) duplex electrical outlets PA2A, centered on each half of the table

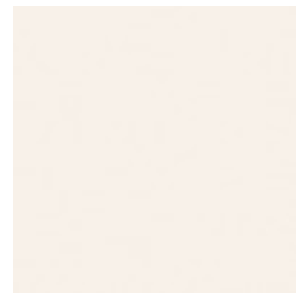

Fenix Bianco Kos



Key T15
Furniture Type Bar hieght round table, 48 ø
Location Street, Business center
Manufacturer Davis
Model Inform bar table 1F-4048-R-ML-FX
Description
Finish/Color Top: matte white laminate, Bianco Kos. Legs: matte white metal
Dimension 48" ø x 42" h
Notes

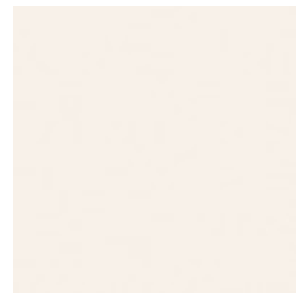

Fenix Bianco Kos

Key T16
Furniture Type Bar hieght round table, 60 ø
Location Street
Manufacturer Davis
Model Inform bar table 1F-4060-R-ML-FX
Description
Finish/Color Top: matte white laminate, Bianco Kos. Legs: matte white metal
Dimension 60" ø x 42" h
Notes

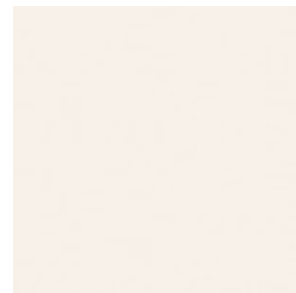

Fenix Bianco Kos

Key T17
Furniture Type Bar hieght rctangular table
Location Business Center
Manufacturer Davis
Model Inform meeting table 1F-43720-R-ML-FX
Description
Finish/Color Top: matte white laminate, Bianco Kos. Legs: matte white metal
Dimension 36" x 72" x custom 34" h
Notes

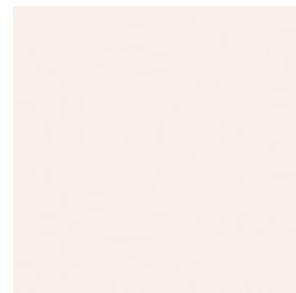

Fenix Bianco Kos

Key	T18
Furniture Type	Butcherblock table, 24" x 66"
Location	166 Boombox
Manufacturer	3Branch
Model	Marker Table MK-6624ADJ-BBK
Description	adjustable height table on casters with brakes
Finish/Color	Top: 1 1/2" thick solid maple fixed top, Legs: stainless steel
Dimension	24" x 66" x 29-41" h
Notes	Flip up duplex outlet, under counter wire management clips



Key	T19
Furniture Type	Butcherblock table, 30" x 84"
Location	218 Makerspace
Manufacturer	3Branch
Model	Marker Table MK-8430ADJ-BBK
Description	adjustable height table on casters with brakes
Finish/Color	Top: 1 1/2" thick solid maple fixed top, Legs: stainless steel
Dimension	30" x 84" x 29-41" h
Notes	Flip up duplex outlet, under counter wire management clips



Key	T20
Furniture Type	Butcherblock table, 42" x 120"
Location	156 YS
Manufacturer	3Branch
Model	Marker Table MK-12042ADJ-BBK
Description	adjustable height table on casters with brakes
Finish/Color	Top: 1 1/2" thick solid maple fixed top, Legs: stainless steel
Dimension	42" x 120" x 29-41" h
Notes	(2) Flip up duplex outlets, under counter wire management clips



Key T21
Furniture Type Butcherblock table, 36" x 60"
Location MR Room
Manufacturer 3Branch
Model Marker Flex Nesting Fliptop Adjustable Table MF-603636-NEST-FIXT-BBK-CAS
Description adjustable height table on casters with brakes, fliptop
Finish/Color Top: 1 1/2" thick solid maple top, Legs: stainless steel
Dimension 36" x 60" x 27-41" h
Notes



Key T22
Furniture Type Fliptop table
Location 146 Book discussion room
Manufacturer KI
Model Pirouette Nesting Rectangular Training table
Description Nesting fliptop table on casters with brake
Finish/Color Top and edge: laminate Monticello Maple LMT, Legs: Chrome
Dimension 30" w x 72" l x 29" h
Notes

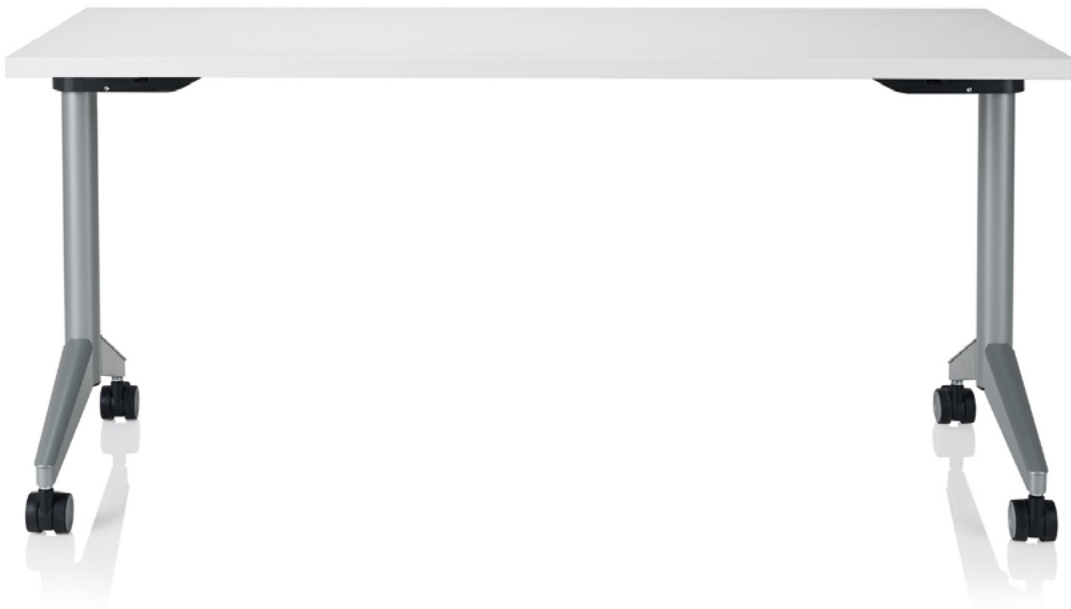

Monticello Maple



Key T23
Furniture Type Fliptop table, powered
Location 211 Business center
Manufacturer KI
Model Pirouette Nesting Rectangular Training table with Activ8
Description Nesting fliptop table on casters with brake
Finish/Color Top and ege: laminate light grey, Legs: chrome CH
Dimension 36" w x 60" l x 29" h
Notes

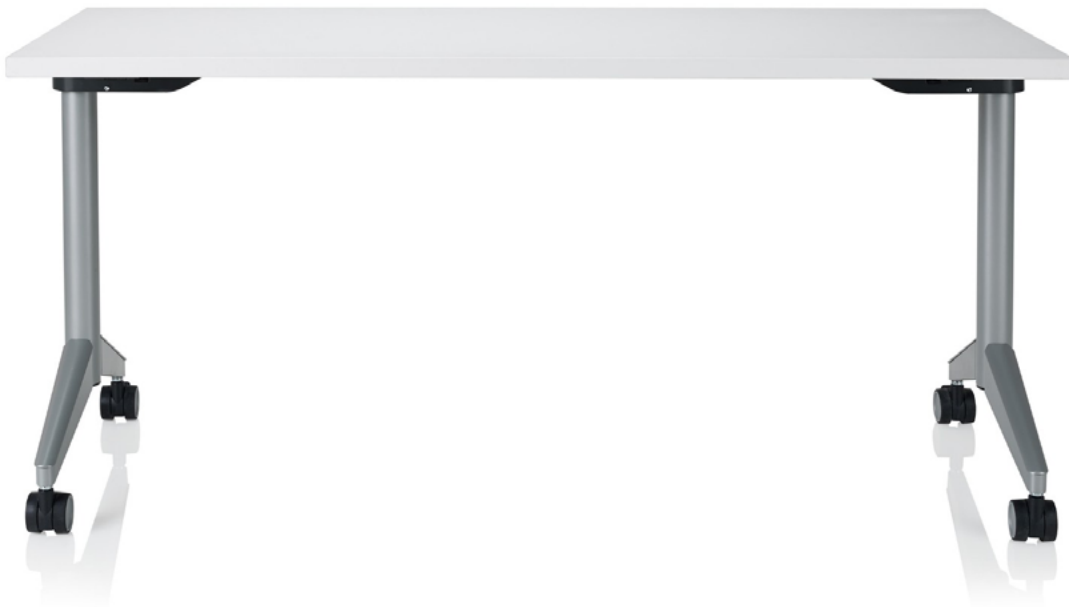

Key T24
Furniture Type Fliptop table with casters
Location 188 Classroom
Manufacturer KI
Model Pirouette Nesting Rectangular Training table
Description Nesting fliptop table on casters with brake
Finish/Color Top and edge: laminate light grey, Legs: chrome CH
Dimension 36" w x 72" l x 29" h
Notes

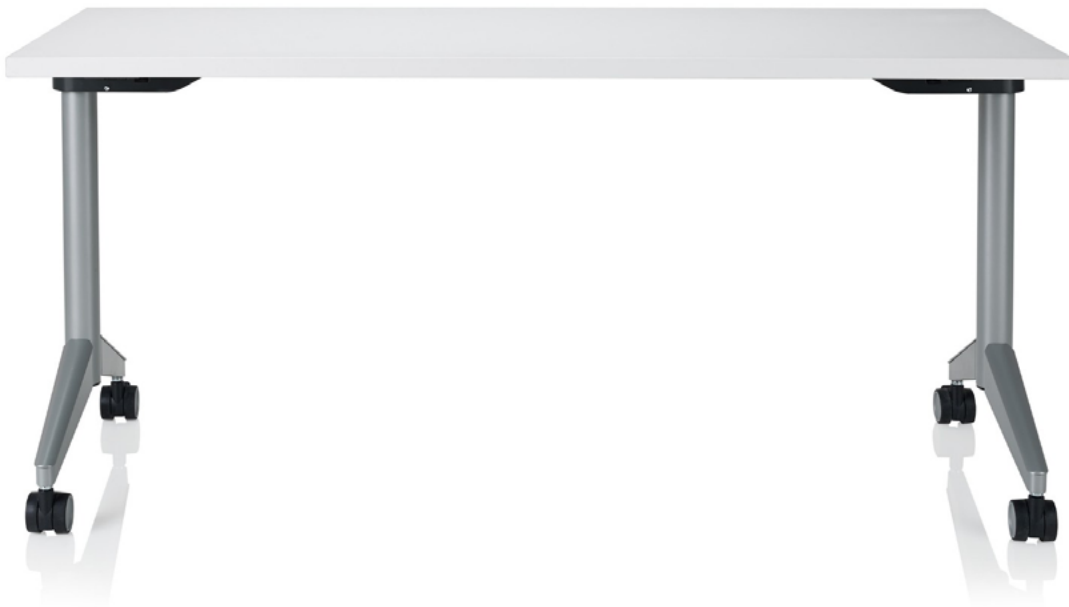

Key	T25
Furniture Type	Adjustable Height Table, 30" x 48"
Location	222 Computer Commons
Manufacturer	Herman Miller
Model	Renew rectangular table with C-foot
Description	
Finish/Color	Top and edge: laminate white 91, Legs: white 91
Dimension	30" x 48" x 27-46"
Notes	-cutout and provide (1) 2.5" grommet kit FV982-91



Key	T26
Furniture Type	Adjustable Height Table, 30" x 66"
Location	222 Computer Commons
Manufacturer	Herman Miller
Model	Renew rectangular table with C-foot
Description	
Finish/Color	Top and edge: laminate white 91, Legs: white 91
Dimension	30" x 66" x 27-46"
Notes	-cutout and provide (1) 2.5" grommet kit FV982-91



Key	T27
Furniture Type	Adjustable Height Table, 30" x 72"
Location	191 Returns
Manufacturer	Herman Miller
Model	Renew rectangular table with C-foot
Description	
Finish/Color	Top and edge: laminate white 91, Legs: white 91
Dimension	30" x 72" x 27-46"
Notes	-cutout and provide (1) 2.5" grommet kit FV982-91



Key	T28
Furniture Type	Adjustable Height Table, 30" x 84"
Location	191 Returns
Manufacturer	Herman Miller
Model	Renew rectangular table with C-foot
Description	
Finish/Color	Top and edge: laminate white 91, Legs: white 91
Dimension	30" x 84" x 27-46"
Notes	-cutout and provide (1) 2.5" grommet kit FV982-91



Key	T29
Furniture Type	CW work table, 30" x 46"
Location	247 Makerspace studio 2
Manufacturer	Herman Miller
Model	Everywhere Table
Description	
Finish/Color	Top and edge: laminate white 91, Legs: white 91
Dimension	30" x 46" (v.i.f.) x 29.5"h
Notes	cutout and provide grommet kits



Key	T30
Furniture Type	CW work table, 30" x 54"
Location	245 Makerspace studio 1
Manufacturer	Herman Miller
Model	Everywhere Table
Description	
Finish/Color	Top and edge: laminate white 91, Legs: white 91
Dimension	30" x 54" x 29.5"h
Notes	cutout and provide grommet kits



Key T31
Furniture Type CW work table, 30" x 72"
Location 180, 181, 182 YS CW
Manufacturer Herman Miller
Model Everywhere Table
Description
Finish/Color Top and edge: laminate white 91, Legs: white 91
Dimension 30" x 72" x 29.5"h
Notes



Key T32
Furniture Type CW work table, 30" x 84"
Location 248 Makerspace studio 3
Manufacturer Herman Miller
Model Everywhere Table
Description
Finish/Color Top and edge: laminate white 91, Legs: white 91
Dimension 30" x 84" x 29.5"h
Notes cutout and provide grommet kits



Key T33

Furniture Type CW work table, 24" x 72"

Location 228-233 CW Rooms

Manufacturer Herman Miller

Model Layout Studio table

Description

Finish/Color Top and edge: laminate white 91, Legs: white 91

Dimension 24" x 72" x 29.5" h

Notes



Key	T34
Furniture Type	Rectangular standing height table, 48" x 84"
Location	Youth Services office
Manufacturer	Herman Miller
Model	Layout Studio table, standing height
Description	
Finish/Color	Top and edge: laminate white 91, Legs: white 91
Dimension	48" x 84" x 41.5"
Notes	cutout and provide grommet kits



Key	T35
Furniture Type	Rectangular meeting table, 48" x 96"
Location	CE meeting room
Manufacturer	Herman Miller
Model	Layout Studio table
Description	
Finish/Color	Top and edge: laminate white 91, Legs: white 91
Dimension	48" x 96" x 29"
Notes	cutout and provide grommet kits, umbilical riser



Key	T36
Furniture Type	Rectangular reading table, 60" x 120"
Location	2nd fl South seating
Manufacturer	Herman Miller
Model	Layout Studio table
Description	
Finish/Color	Top and edge: laminate white 91, Legs: white 91
Dimension	60" x 120" x 29" h
Notes	cutout and provide grommet kits, umbilical riser



Key	T37
Furniture Type	Rectangular table. 60" x 16'-0"
Location	2nd fl East seating
Manufacturer	Herman Miller
Model	Layout Studio Table, No rail
Description	Reading table with electrical grommets
Finish/Color	Top and edge: laminate white 91, Legs: white 91
Dimension	5'-0" w x 16'-0" l x 29" h, with (2) 8' table tops.
Notes	Provide Thrive Logic G1000 power grommets with 4 simplex receptacles in white finish centered on each tabletop: (2) Y1425CA-06-91. Provide wire trays, and (2) Umbilical Risers GNWFG-91.



Key	T38
Furniture Type	Rectangular table, 60" x 21'-0"
Location	Reading Room
Manufacturer	Herman Miller
Model	Layout Studio Table, No rail
Description	Reading table with electrical grommets
Finish/Color	Oak on Ash wood veneer table top, white legs
Dimension	4'-6" w x 21'-0" l x 29" h, with (3) 7' table tops.
Notes	Provide Logic grommets with 3 simplex receptacles with plug cord: (4) Y1425EA-10-92, (2) Y1425EA-20-91 Provide wire trays, and (1) Umbilical Risers GNWFG-91.



Oak on Ash veneer

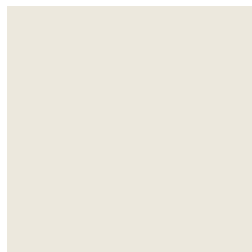

Laminate White 91

Key	T39
Furniture Type	Rectangular reading carrel table, 60" x 16'-0"
Location	2nd fl East seating
Manufacturer	Herman Miller
Model	Layout Studio Table
Description	Reading table with screens for 8 work stations
Finish/Color	91 white laminate table top, 91 white legs, 91 white laminate screens
Dimension	5'-0" w x 16'-0" l x 29" h, with (2) 8' table tops. 46" h aff screens.
Notes	Provide End of run laminate screens, Deskup laminate screens, Delineation framed screens with custom laminate infill. Provide access cover, duplex power outlets at each work stations for hardwiring to floor outlets, wire trays, and floor power entry cover at central Engage legs.

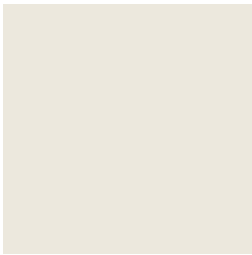

Laminate White 91

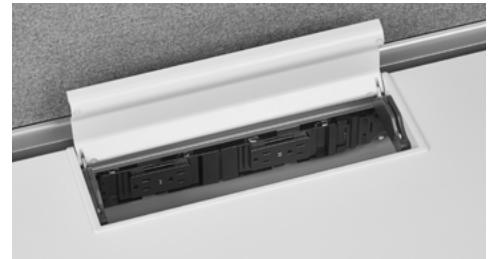

Key	T40
Furniture Type	Rectangular staff work table, 60" x 11'-0", with bookcase
Location	CE office 3
Manufacturer	Herman Miller
Model	Layout Studio table
Description	workstation with screens, end bookcases, power at desktop
Finish/Color	Top and edge: laminate white 91, Legs: white 91, Screens: Vapor Grey 4701
Dimension	60" x 132", with bookcase
Notes	



Key	S1
Furniture Type	Staff freestanding work desk, 96"
Location	Lab
Manufacturer	Herman Miller
Model	Canvas Office Landscape Private Office
Description	freestanding work desk, w/ full height laminate modesty panel
Finish/Color	Top: laminate white 91, Legs: laminate white 91, Modesty panel: laminate white 91
Dimension	24" x 96" x 29" h
Notes	Provide cutout for 1 grommet & umbilical riser GNWF-G-91.

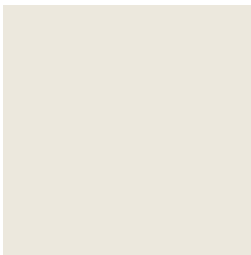

Laminate White 91

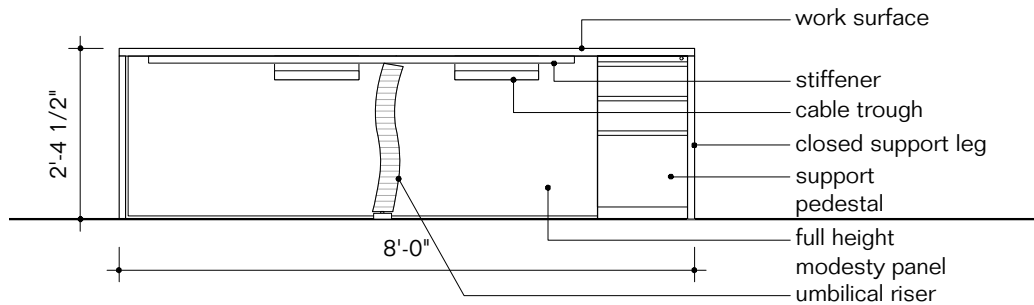

Elevation
Not to scale

Key S2

Furniture Type Staff work desk for 3, 17'-10" long

Location 130 book mobile office

Manufacturer Herman Miller

Model Canvas Office Landscape workstations

Description

Finish/Color Top: laminate white 91, Legs: white 91, Tackboard: Ground Cloth Vapor Grey 4701

Dimension 17'-10" long

Notes

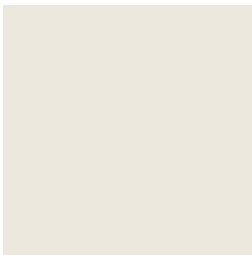

Laminate White 91

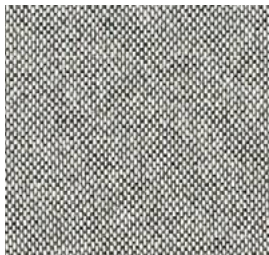

Ground cloth, Vapor Grey

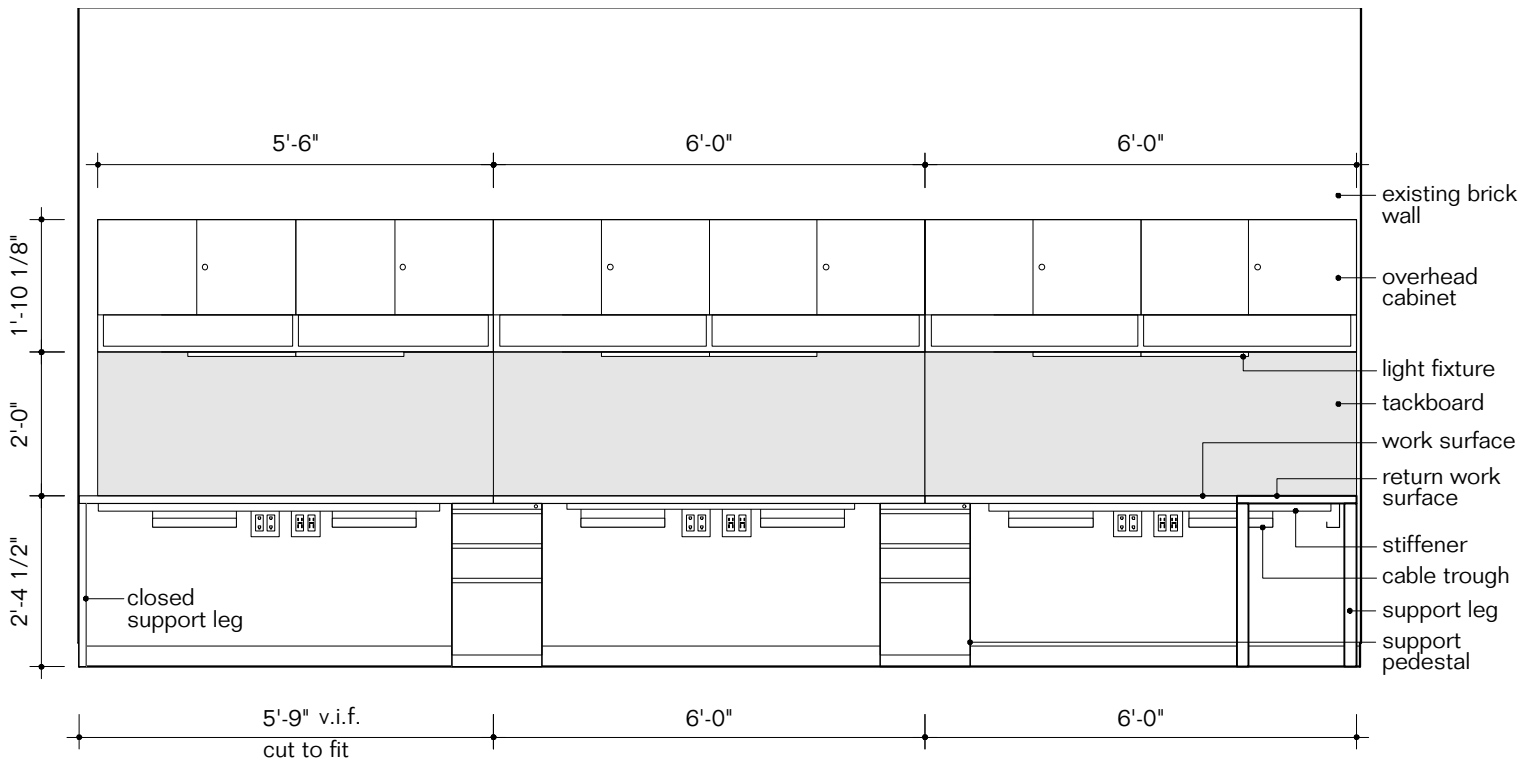

Elevation
Not to scale

Key S3

Furniture Type Staff work desk without overhead cabinet, 11'-9" long

Location 131 call center west wall

Manufacturer Herman Miller

Model Canvas Office Landscape workstations

Description

Finish/Color Top: laminate white 91, Legs: laminate white 91

Dimension 11'-9" w x 30" d

Notes

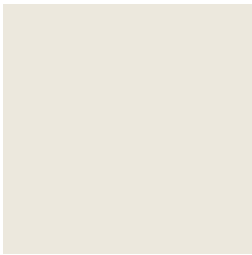

Laminate White 91

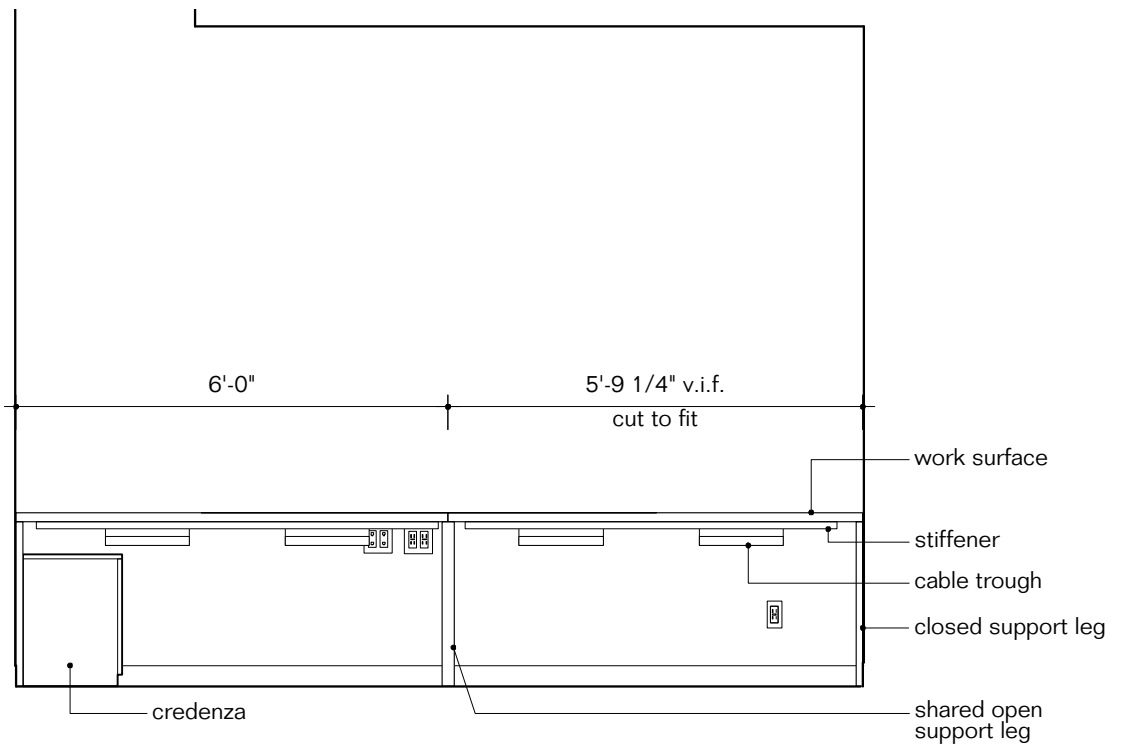

Elevation
Not to scale

Key S4

Furniture Type Staff work station without overhead cabinet, 11'-0" long

Location 131 call center east wall

Manufacturer Herman Miller

Model Canvas Office Landscape workstations

Description

Finish/Color Top: laminate white 91, Legs: laminate white 91

Dimension 17'-10" x 29" h

Notes

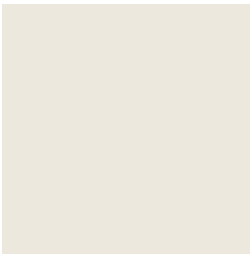

Laminate White 91

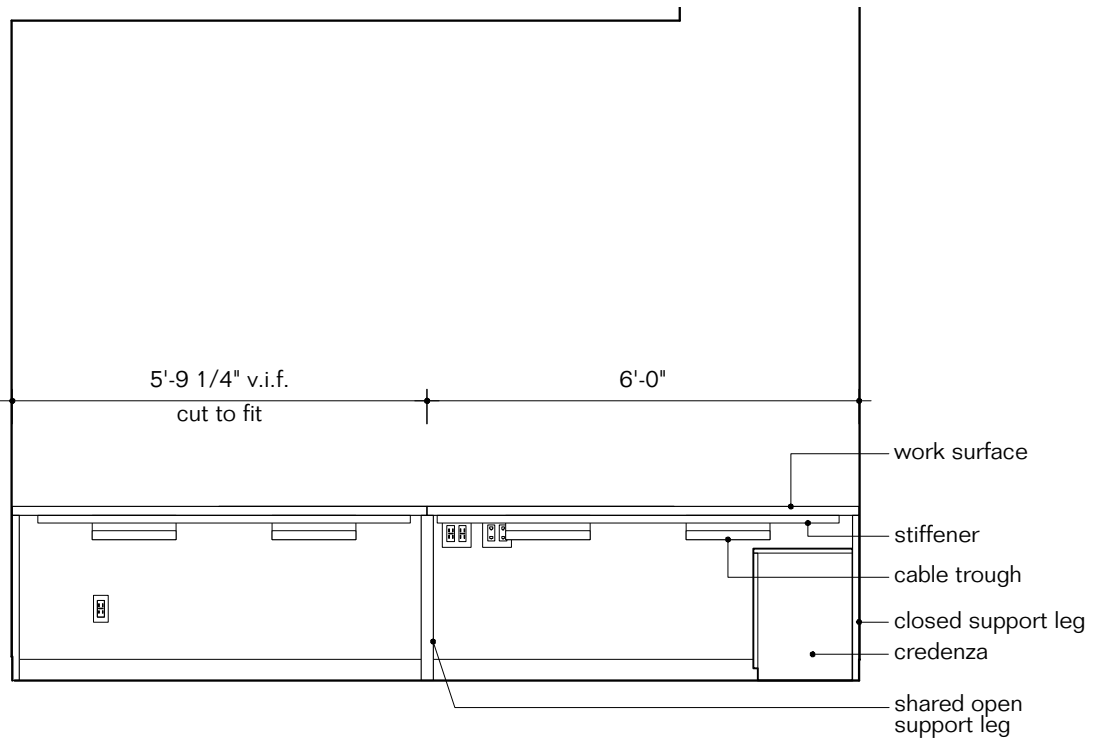

Elevation
Not to scale

Key S5
Furniture Type Staff private office, 7'w x 8'd
Location 135 office
Manufacturer Herman Miller
Model Canvas Office Landscape workstations
Description
Finish/Color Top: laminate white 91, Legs: laminate white 91, Tackboard/Screens: Vapor Grey 4701
Dimension 7'w x 8'd

Notes

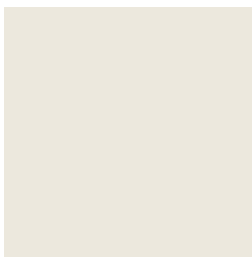

Laminate White 91

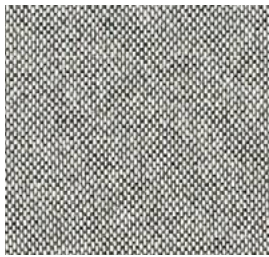

Ground cloth, Vapor Grey

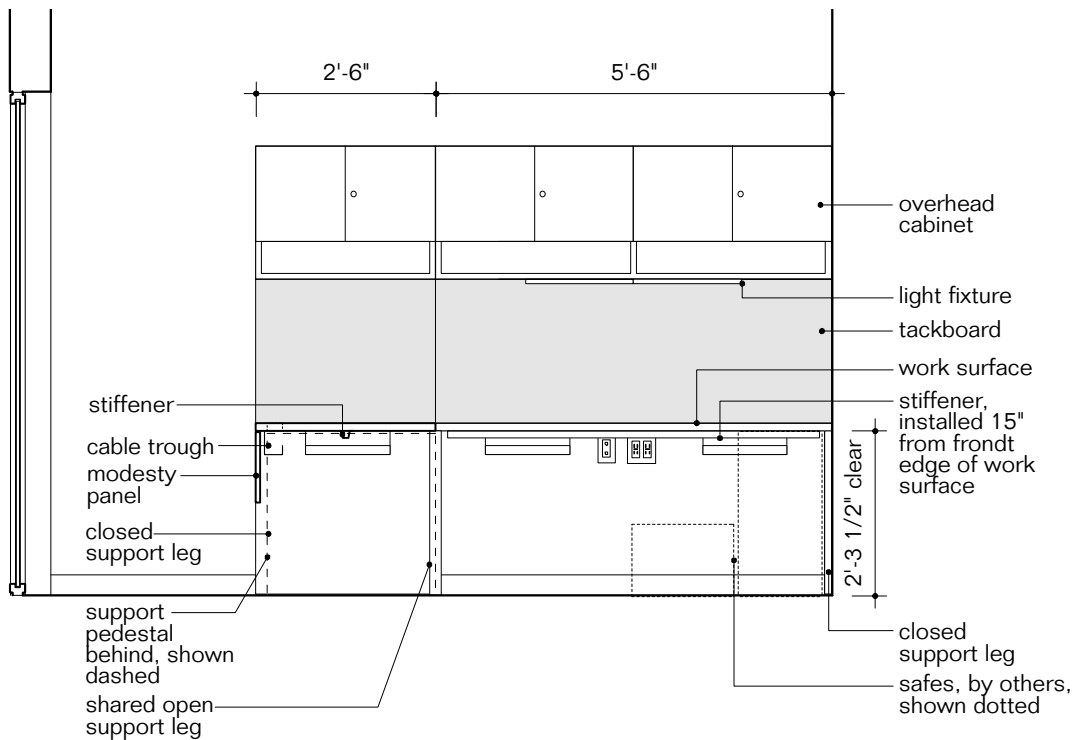

Elevation
 Not to scale

Key S6

Furniture Type Staff work desk, 8'w

Location 136 office west wall

Manufacturer Herman Miller

Model Canvas Office Landscape workstations

Description

Finish/Color Top: laminate white 91, Legs: laminate white 91, Tackboard/Screens: Vapor Grey 4701

Dimension 96" w x 30" d

Notes

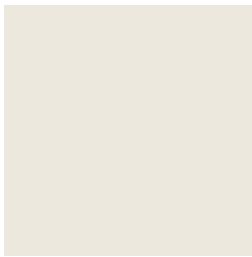

Laminate White 91

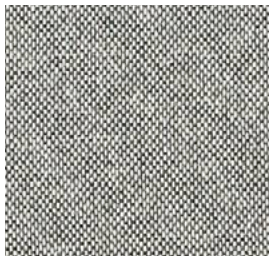

Ground cloth, Vapor Grey

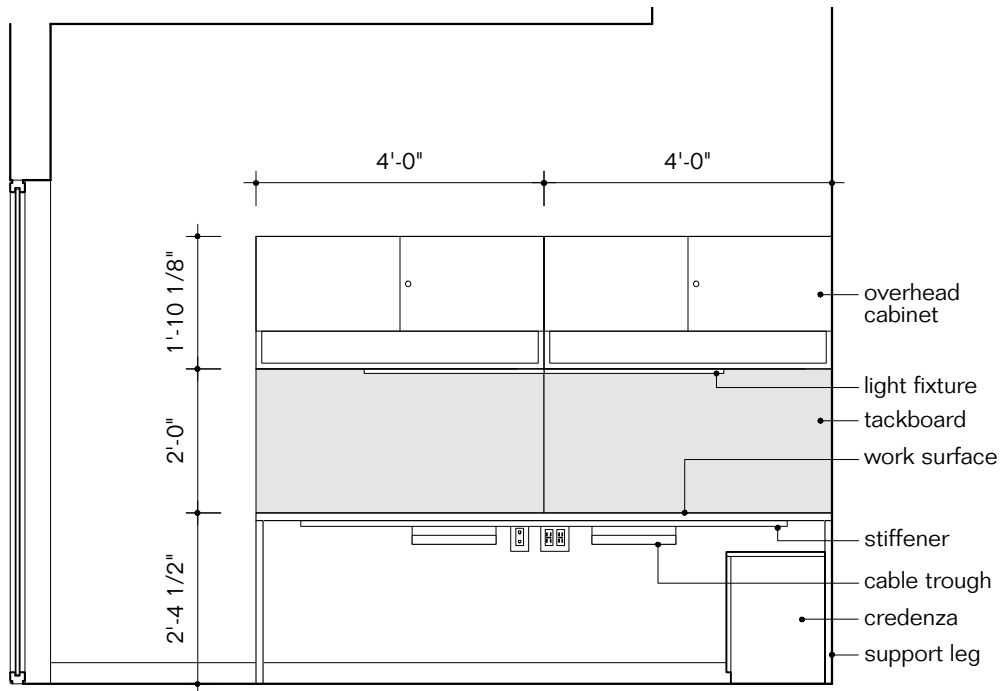

Elevation
Not to scale

Key S7

Furniture Type Staff work desk, 8'w

Location 136 office east wall, 137office, 138 office

Manufacturer Herman Miller

Model Canvas Office Landscape workstations

Description

Finish/Color Top: laminate white 91, Legs: laminate white 91, Tackboard/Screens: Vapor Grey 4701

Dimension 96" w x 30" d

Notes

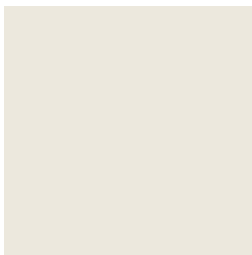

Laminate White 91

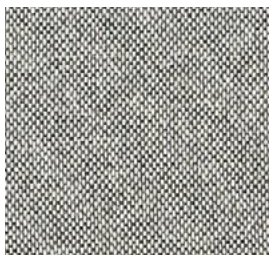

Ground cloth, Vapor Grey

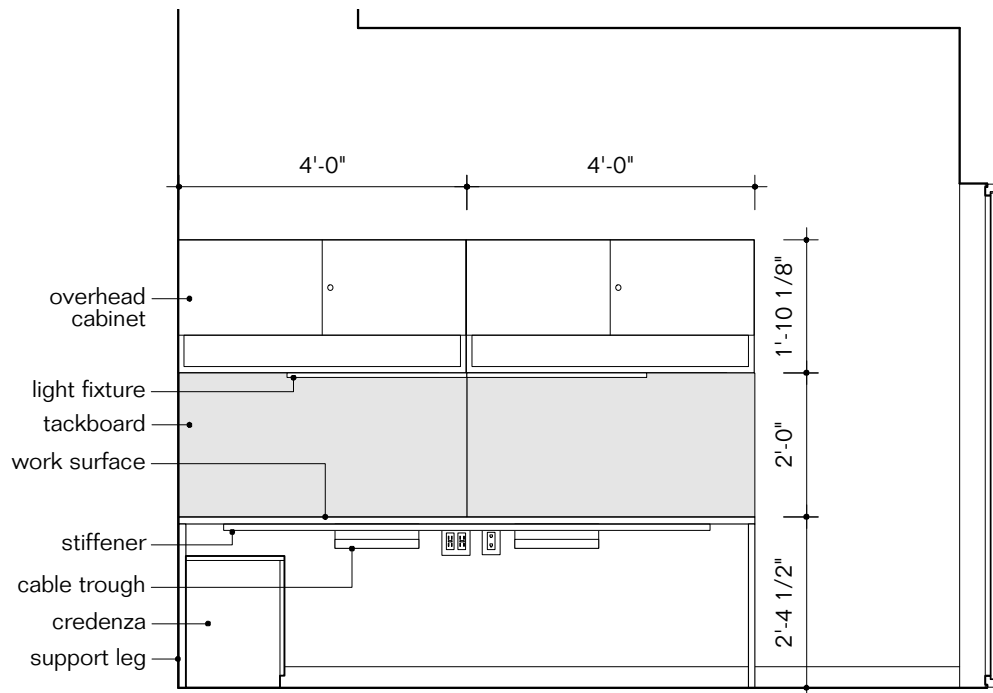

Elevation
Not to scale

Key S8
Furniture Type Staff work desk without overhead cabinet, 8'w
Location 139 office
Manufacturer Herman Miller
Model Canvas Office Landscape workstations
Description
Finish/Color Top: laminate white 91, Legs: laminate white 91
Dimension 96" w x 30" d
Notes

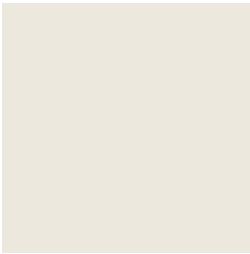

Laminate White 91

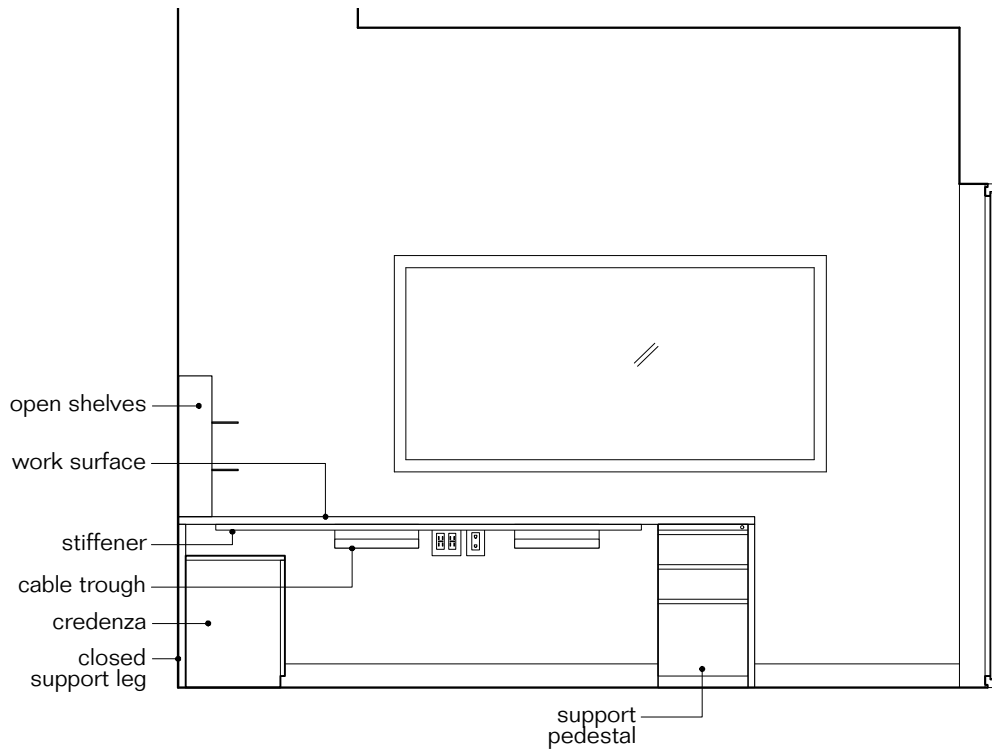

Elevation
 Not to scale

Key S9
Furniture Type Staff work desk, corner
Location 191 Returns
Manufacturer Herman Miller
Model Canvas Office Landscape workstations
Description
Finish/Color Top: laminate white 91, Legs: laminate white 91
Dimension 72" w x 7'-11" d
Notes

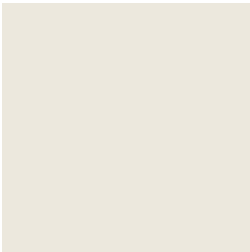

Laminate White 91



Key S10

Furniture Type Staff work desk for 8, 67'-6"

Location 191 Returns

Manufacturer Herman Miller

Model Canvas Office Landscape workstations

Description

Finish/Color Top: laminate white 91, Legs: laminate white 91, Tackboard/Screens: Vapor Grey 4701

Dimension 67'6" w x 30" d

Notes

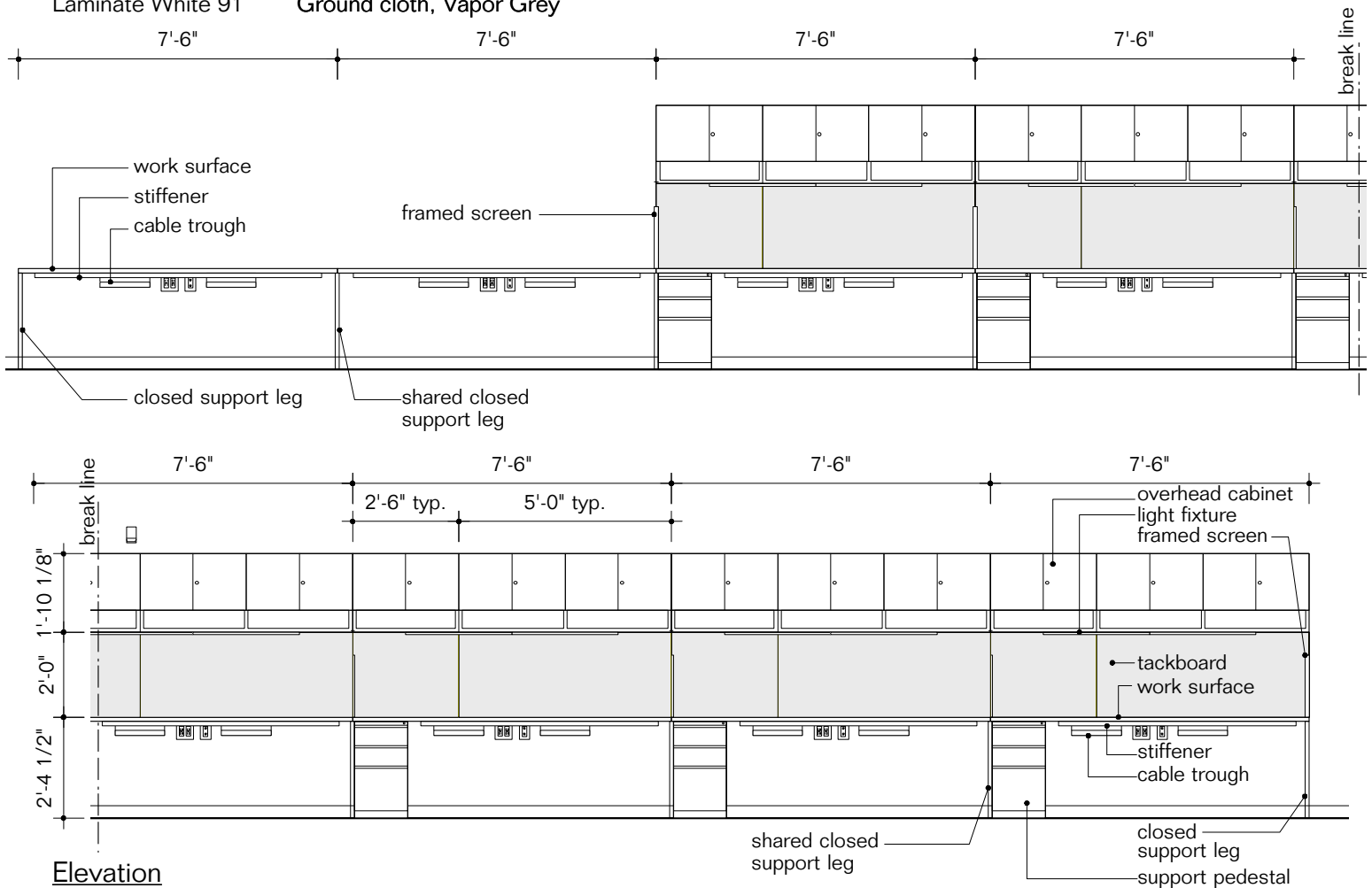
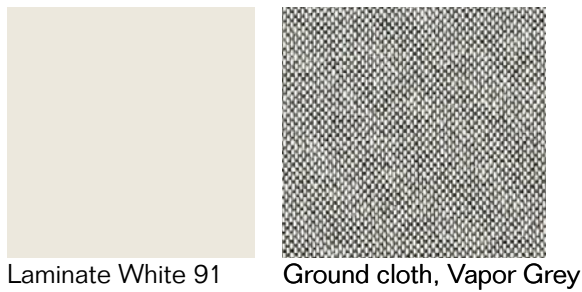

Elevation
Not to scale

Key S11
Furniture Type Staff work stations for 3, 16'-6" long
Location 153 CE office 3
Manufacturer Herman Miller
Model Canvas Office Landscape workstations
Description
Finish/Color Top: laminate white 91, Legs: laminate white 91, Tackboard/Screens: Vapor Grey 4701
Dimension 16'-6" w x 30" d

Notes

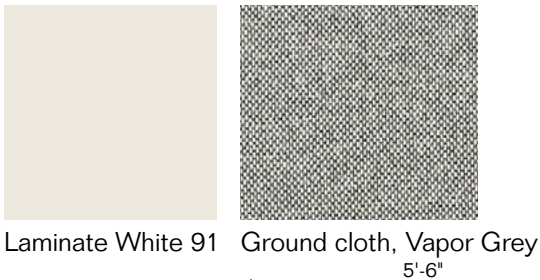

West wall
 Elevation
 Not to scale

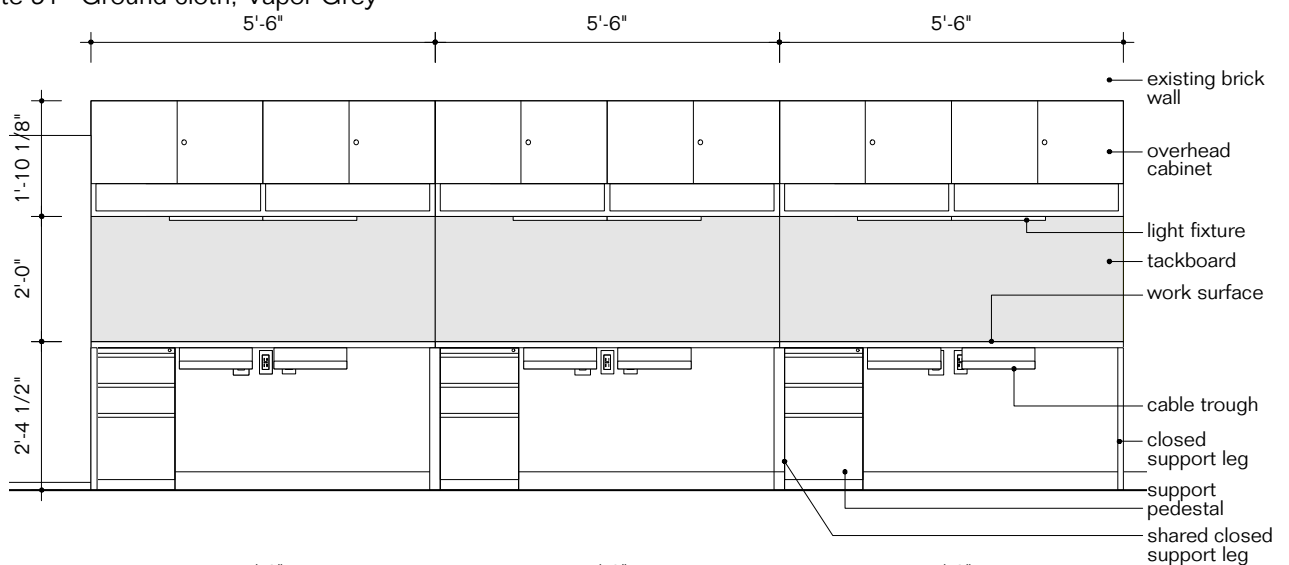

East wall
 Elevation
 Not to scale

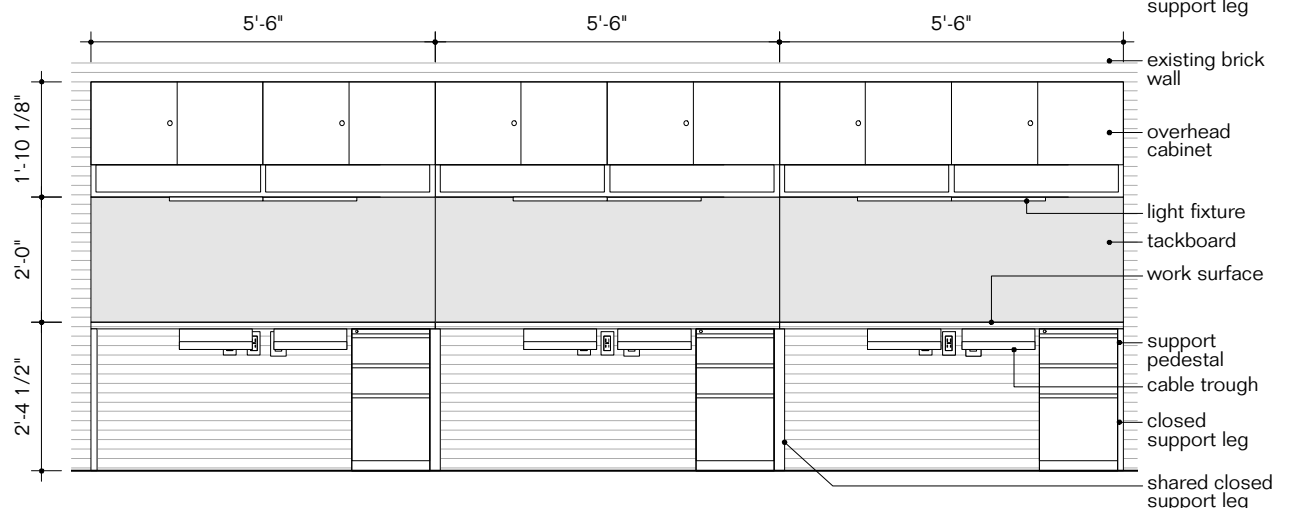

Key S12

Furniture Type Staff private office, 8'w x 7'-6"

Location 151 CE office 1

Manufacturer Herman Miller

Model Canvas Office Landscape workstations

Description

Finish/Color Top: laminate white 91, Legs: laminate white 91, Tackboard/Screens: Vapor Grey 4701

Dimension 8'w x 7'-6"

Notes

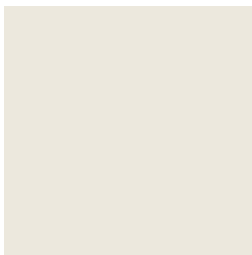

Laminate White 91

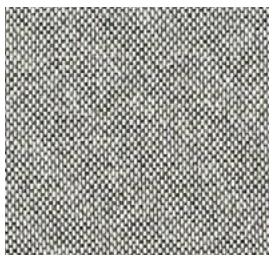

Ground cloth, Vapor Grey

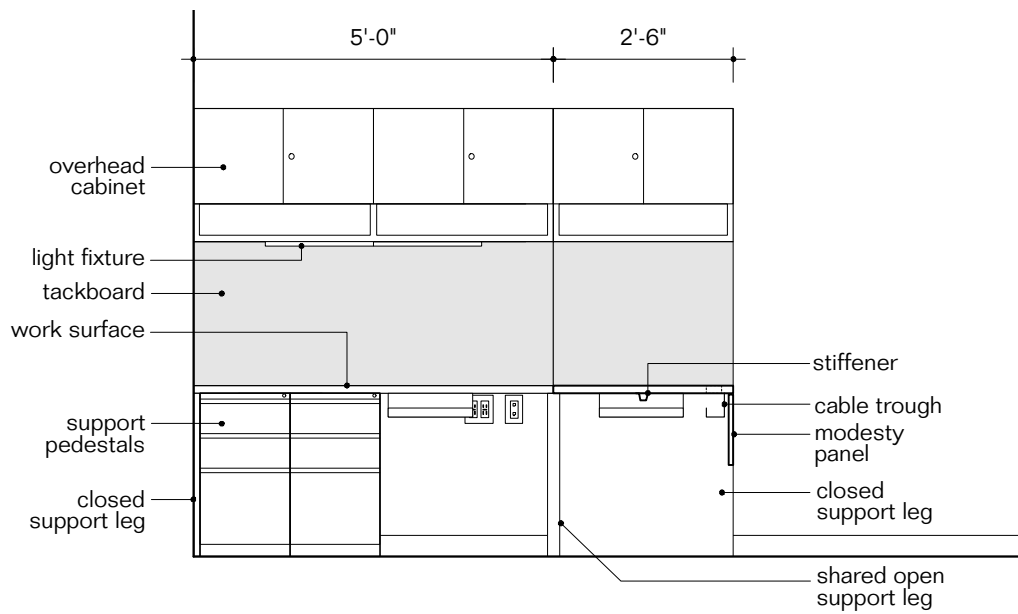

Elevation
Not to scale

Key S13
Furniture Type Staff work desk for 3, 13'-11" long
Location 149 volunteer room
Manufacturer Herman Miller
Model Canvas Office Landscape workstations
Description
Finish/Color Top: laminate white 91, Legs: laminate white 91, Tackboard/Screens: Vapor Grey 4701
Dimension 16'-6" w x 30" d

Notes

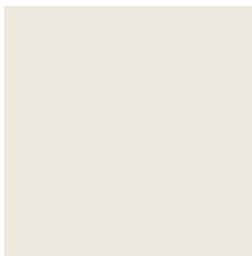

Laminate White 91

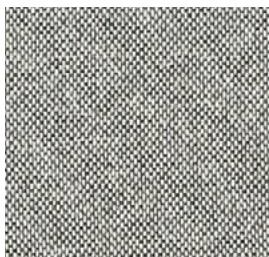

Ground cloth, Vapor Grey

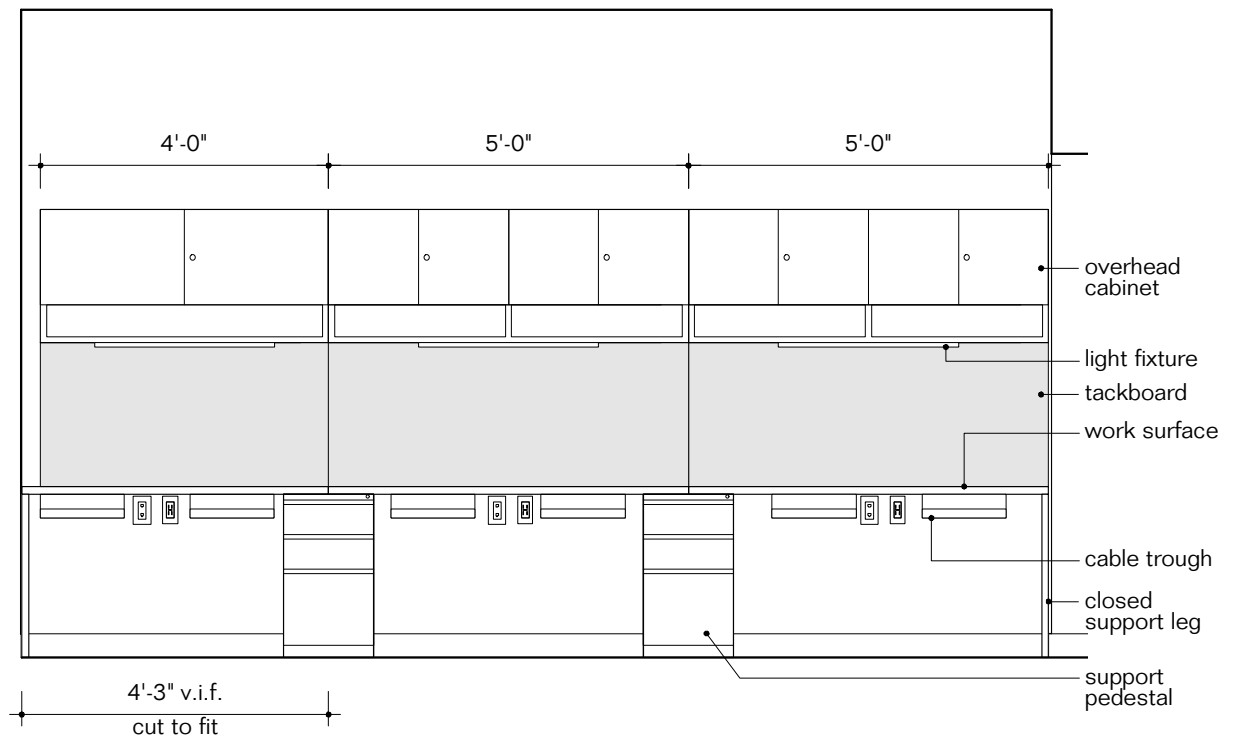

Elevation
 Not to scale

Key S14
Furniture Type Staff work desk for 2, 10'-9.5" long
Location 194 YA office
Manufacturer Herman Miller
Model Canvas Office Landscape workstations
Description
Finish/Color Top: laminate white 91, Legs: laminate white 91, Tackboard/Screens: Vapor Grey 4701
Dimension 10'-9.5" w x 30" d

Notes

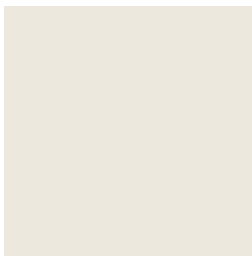

Laminate White 91

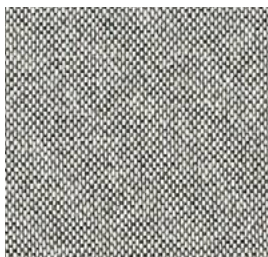

Ground cloth, Vapor Grey

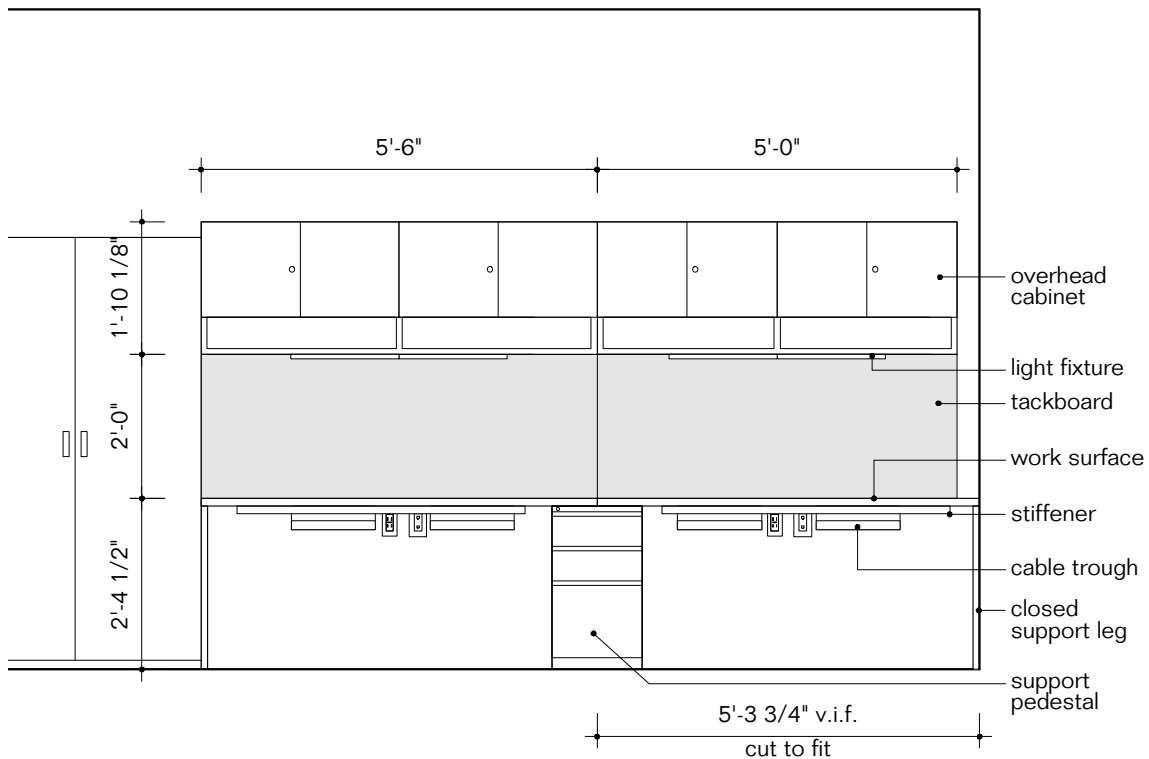

Elevation
Not to scale

Key S15

Furniture Type Staff work desk for 2, 8'-10.5" long

Location 172 YS office

Manufacturer Herman Miller

Model Canvas Office Landscape workstations

Description

Finish/Color Top: laminate white 91, Legs: laminate white 91, Tackboard/Screens: Vapor Grey 4701

Dimension 8'-10.5" w x 30" d

Notes

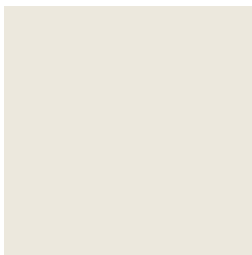

Laminate White 91

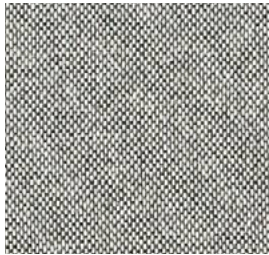

Ground cloth, Vapor Grey

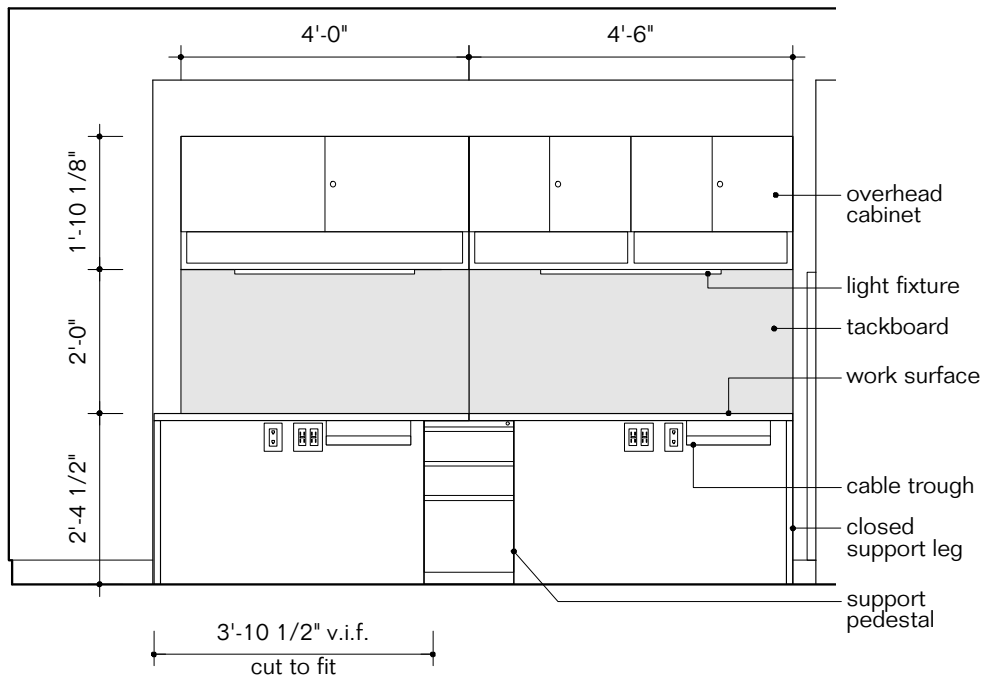

Elevation
Not to scale

Key S16
Furniture Type Staff work desk for 2, 9' long
Location 251 staff
Manufacturer Herman Miller
Model Canvas Office Landscape workstations
Description
Finish/Color Top: laminate white 91, Legs: laminate white 91, Tackboard/Screens: Vapor Grey 4701
Dimension 9'w x 30" d

Notes

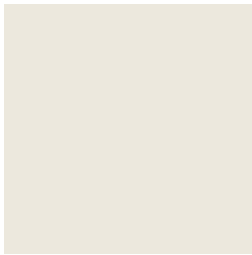

Laminate White 91

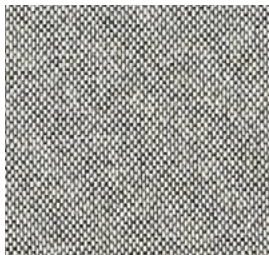

Ground cloth, Vapor Grey

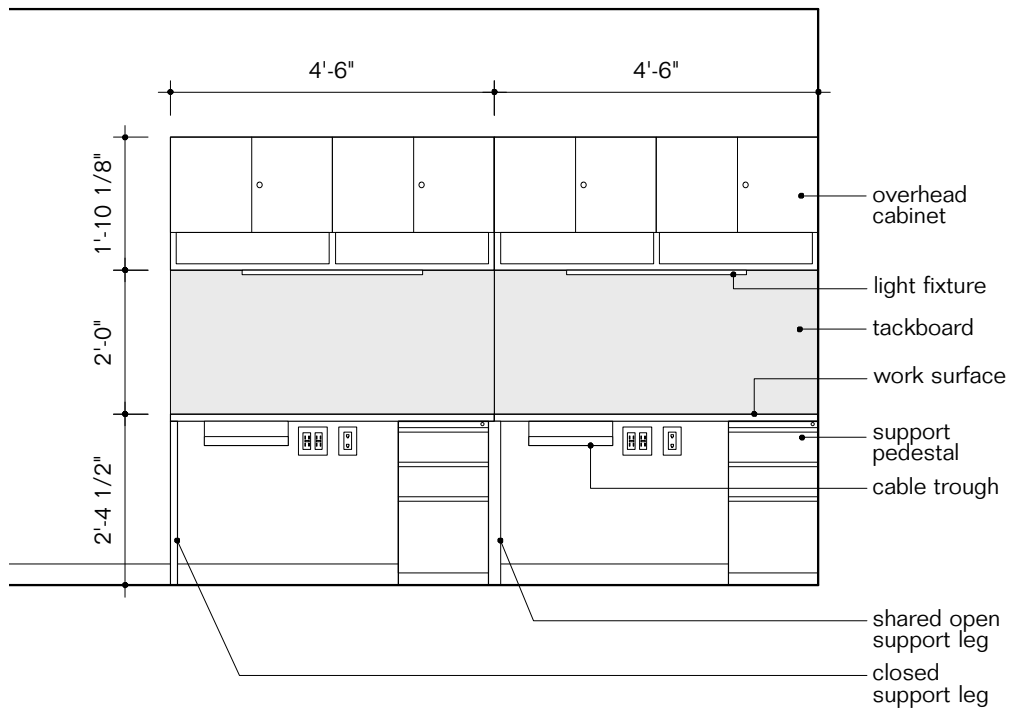

Elevation
 Not to scale

Key	M1A
Furniture Type	Mobile whiteboard and Tackboard
Location	156 YA
Manufacturer	Vitra
Model	Dancing Wall
Description	Whiteboard, or fabric tackboard
Finish/Color	(2) whiteboard panels, (2) tackboards
Dimension	
Notes	provide cable tray and power outlets



Key	M1B
Furniture Type	Mobile whiteboard and Tackboard, for TV
Location	156 YA
Manufacturer	Vitra
Model	Dancing Wall
Description	Whiteboard, or fabric tackboard
Finish/Color	(2) whiteboard panels, (2) tackboards
Dimension	
Notes	provide cable tray and power outlets



Key M1C
Furniture Type Mobile whiteboard and Tackboard
Location 211 Business Center
Manufacturer Vitra
Model Dancing Wall
Description Whiteboard, or fabric tackboard
Finish/Color (4) whitebord panels
Dimension
Notes



Key	M1D
Furniture Type	Mobile whiteboard, for TV
Location	218 Makerspace, 211 Business Center
Manufacturer	Vitra
Model	Dancing Wall
Description	Whiteboard, or fabric tackboard
Finish/Color	(4) whitebord panels
Dimension	
Notes	provide cable tray and power outlets



Key	M2
Furniture Type	Adjustable height lecturn
Location	166 Boombox, 211 Business Center
Manufacturer	Haskell
Model	Sit to stand lecturn
Description	Sit to stand, locking casters, grommet
Finish/Color	4799 Platinum metallic
Dimension	22" x 26" x 28 1/4"-42"
Notes	



Key M3
Furniture Type Power outlet stand
Location 156 YA
Manufacturer Steelcase
Model Thread Power Hub, lounge height
Description
Finish/Color 4799 Platinum metallic
Dimension 8" \varnothing x 30" h
Notes



Key	M4
Furniture Type	Glass top for existing Barcelona Table base
Location	2nd fl East seating
Manufacturer	custom
Model	
Description	Clear tempered glass panel
Finish/Color	
Dimension	44" ø x 3/4" thick
Notes	

Key M5
Furniture Type Open shelves cabinet
Location 191 Returns
Manufacturer Herman Miller
Model Tu Storage Bookcase LG500-36-38-XS-91
Description
Finish/Color white 91
Dimension 36" w x 15" d x 39 1/8" h
Notes

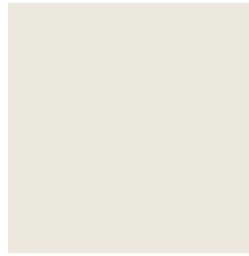

White 91

Key M6
Furniture Type Desk height cabinet with doors
Location 191 Returns
Manufacturer Herman Miller
Model Canvas Office Landscape Wood High Credenza with doors and top
Description lockable doors with bar pulls, center divider, 2 adj. shelves
Finish/Color white 91
Dimension 42" w x 20" d x 27 3/8" h
Notes

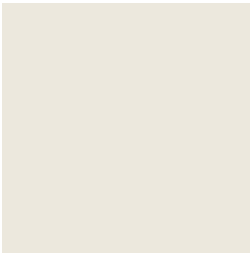

Laminate White 91

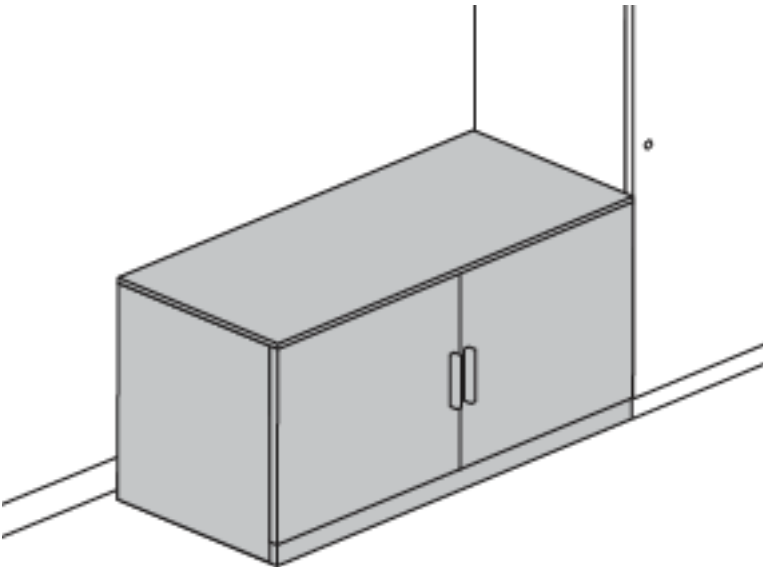

Key M7
Furniture Type Tall cabinet, 30" w
Location 153 CE office 3
Manufacturer Herman Miller
Model Canvas Office Landscape Wood Freestanding Bookcase
Description (4) adj. sheves included, lockable door with touch latch
Finish/Color white 91
Dimension 30" w x 24" d x 68" h

Notes

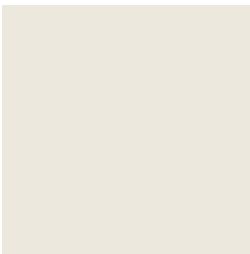

Laminate White 91

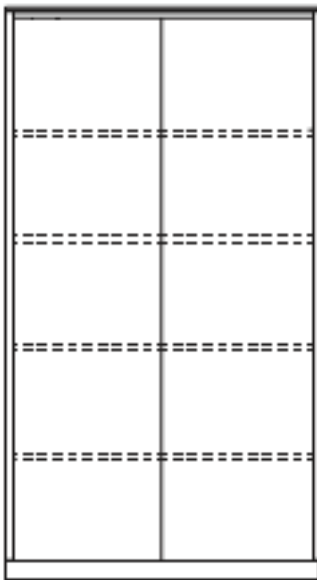

Key M8
Furniture Type Tall cabinet, 42" w
Location 194 YA office
Manufacturer Herman Miller
Model Tu Bookcase
Description center divider and 8 adj. shelves, lockable doors with flush pull
Finish/Color Laminate white 91
Dimension 42" w x 20" d x 72" h

Notes

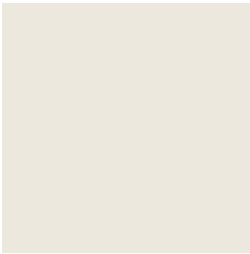

Laminate White 91

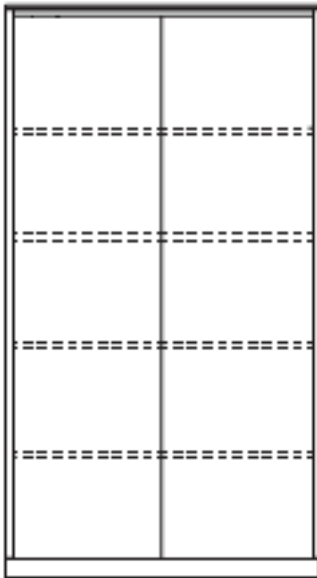

Key M9
Furniture Type Wardrobe
Location 153 CE office 3
Manufacturer Herman Miller
Model Tu Wardrobe
Description
Finish/Color Laminate white 91
Dimension 36" w x 24" d x 72" h
Notes

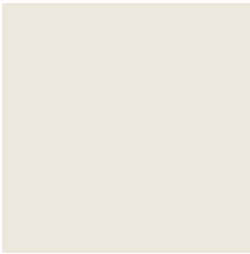

Laminate White 91

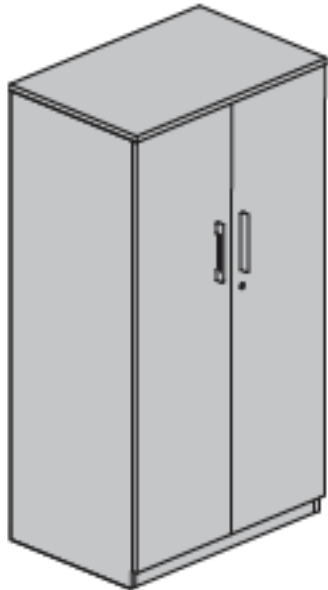

Key	M10
Furniture Type	Gaming cabinet
Location	153 YA gaming
Manufacturer	Herman Miller
Model	Canvas Office Landscape Wood High Credeza with doors and top
Description	lockable doors with bar pulls, (1) adj shelf, 72" w Thick top
Finish/Color	Laminate white 91
Dimension	72" w x 20" d x 27 3/8" h
Notes	for each credenza: for cable passthrough, custom cutout in back panel and provide (1) 2.5" ø grommet kit FV982-91, centered to back panel of credenza. for ventilation, custom cutouts in top panel and outside side panel and provide (2) sets of 4" ø air vent grommet

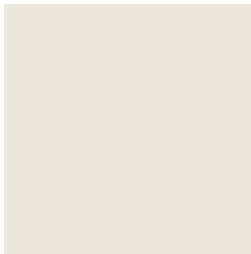

Laminate White 91

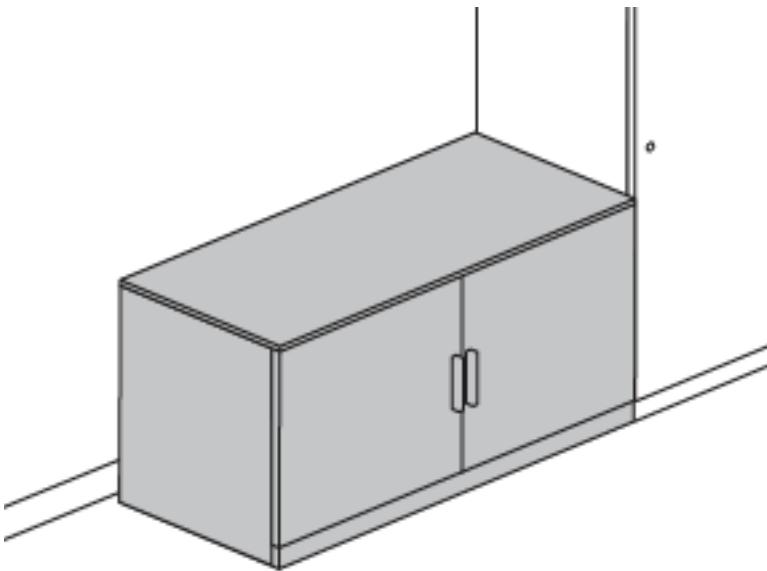

Key M11A
Furniture Type Utility Cart, with 2 shelves
Location 218 Makerspace
Manufacturer Global Industrial
Model 2 Shelf steel stock cart
Description
Finish/Color Standard painted grey steel
Dimension 36" w 24" d x 32" h
Notes



Key M11B
Furniture Type Utility Cart, with 3 shelves
Location 218 Makerspace
Manufacturer Global Industrial
Model 3 shelf steel stock cart
Description
Finish/Color Standard painted grey steel
Dimension 36" w 24" d x 32" h
Notes



4. See Exhibit C – Furniture Plan, which is attached and incorporated by this reference. All furniture furnished and delivered by the Bidder shall be delivered to Skokie Public Library within the time scheduled for delivery and shall be assembled by the Bidder in the corresponding locations identified in this Furniture Plan.

5. **Delivery Requirements.** The Library will accept deliveries of specified furniture at the shipping and receiving area on the south side of the building, or through the double doors on the east side of the building. Lift gate trucks or box trucks may be used for deliveries. Semi-trailer trucks may not be used for deliveries due to accessibility constraints.

**EXHIBIT C – FURNITURE PLANS PREPARED
BY ANDREW BERMAN ARCHITECT DATED 10.4.19**

END OF CONTRACT SPECIFICATIONS.

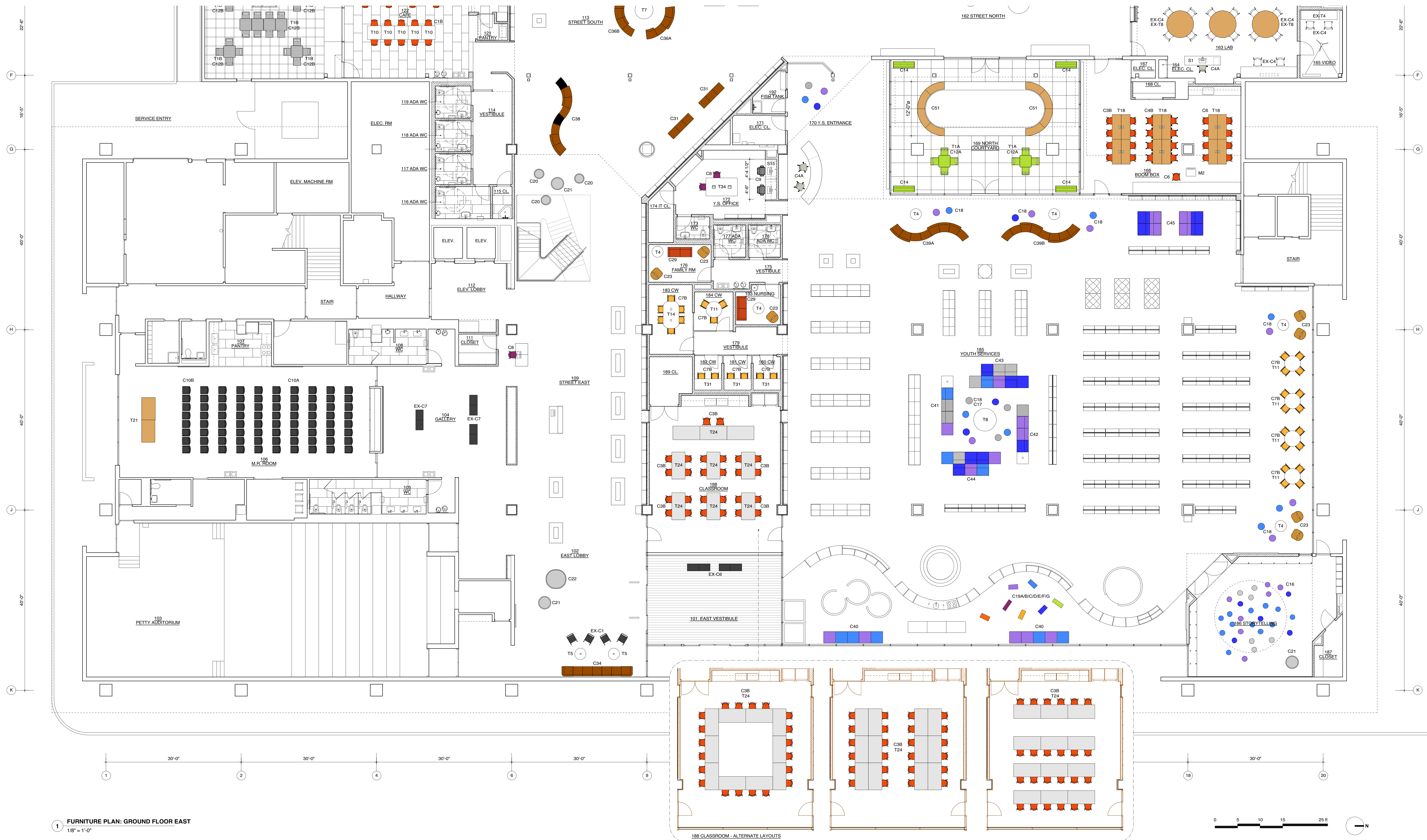

1 FURNITURE PLAN: GROUND FLOOR EAST
1/8" = 1'-0"

REVISIONS:

ISSUE	DATE
ISSUED FOR PRICING	05.04.2019
SCHEMATIC DESIGN	01.16.2019
DESIGN DEVELOPMENT	04.26.2019
ISSUED FOR SHELVING PRICING	06.03.2019
50% CD	07.16.2019
BID SET	09.30.2019
ADDENDUM #2	10.14.2019
FURNITURE ISSUED FOR BID	11.08.2019

NOTE:
REFER TO FURNITURE SCHEDULE AND FURNITURE SPECIFICATIONS FOR DETAILS.

PROJECT:
SKOKIE PUBLIC LIBRARY
5215 OAKTON STREET
SKOKIE, IL 60077

ARCHITECT:
ANDREW BERMAN ARCHITECT
77 CHAMBERS STREET
NEW YORK, NY 10007
P 212 226 5998

MEP ENGINEER:
WMA CONSULTING ENGINEERS
815 SOUTH WABASH AVENUE
CHICAGO, IL 60605
P 312 870 5104

STRUCTURAL ENGINEER:
THE STRUCTURAL GROUP
707 LAKE COOK ROAD, SUITE 300
DEERFIELD, IL 60015
P 847 562 1977

LIGHTING DESIGNER:
SCHULER SHOOK
750 NORTH ORLEANS, SUITE 400
CHICAGO, IL 60654
P 312 374 4335

ACOUSTICAL CONSULTANT:
THRESHOLD ACOUSTICS LLC
141 WEST JACKSON BLVD, SUITE 2080
CHICAGO, IL 60604
P 312 396 1400

GRAPHICS & WAYFINDING:
NEIL DONNELLY STUDIO
603 BERGEN STREET, 201
BROOKLYN, NY 11238
P 917 373 7471

SHEET TITLE:
FURNITURE PLAN
GROUND FLOOR EAST

SCALE: 1/8" = 1'-0" DATE: 10.04.2019
DRAWN: AM CHECKED: AB
SEAL: SHEET NO.:

I-111.00



FURNITURE PLAN: GROUND FLOOR WEST
1/8" = 1'-0"

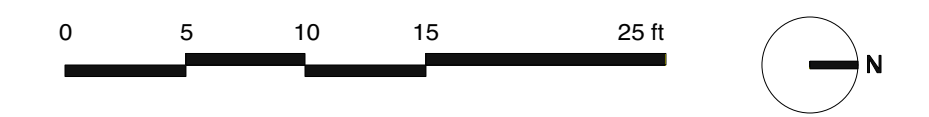

REVISIONS:

ISSUE	DATE
ISSUED FOR PRICING	05.04.2019
SCHEMATIC DESIGN	01.16.2019
DESIGN DEVELOPMENT	04.26.2019
ISSUED FOR SHELVING PRICING	06.03.2019
50% CD	07.16.2019
BID SET	09.30.2019
ADDENDUM #2	10.14.2019
FURNITURE ISSUED FOR BID	11.06.2019

NOTE:
REFER TO FURNITURE SCHEDULE AND FURNITURE SPECIFICATIONS FOR DETAILS.

PROJECT:
SKOKIE PUBLIC LIBRARY
5215 OAKTON STREET
SKOKIE, IL 60077

ARCHITECT:
ANDREW BERMAN ARCHITECT
77 CHAMBERS STREET
NEW YORK, NY 10007
P 212 226 5998

MEP ENGINEER:
WMA CONSULTING ENGINEERS
815 SOUTH WABASH AVENUE
CHICAGO, IL 60605
P 312 870 5104

STRUCTURAL ENGINEER:
THE STRUCTURAL GROUP
707 LAKE COOK ROAD, SUITE 300
DEERFIELD, IL 60015
P 847 562 1977

LIGHTING DESIGNER:
SCHULER SHOOK
750 NORTH ORLEANS, SUITE 400
CHICAGO, IL 60654
P 312 374 4335

ACOUSTICAL CONSULTANT:
THRESHOLD ACOUSTICS LLC
141 WEST JACKSON BLVD, SUITE 2080
CHICAGO, IL 60604
P 312 396 1400

GRAPHICS & WAYFINDING:
NEIL DONNELLY STUDIO
603 BERGEN STREET, 201
BROOKLYN, NY 11238
P 917 373 7471

SHEET TITLE:
**FURNITURE PLAN
GROUND FLOOR WEST**

SCALE: 1/8" = 1'-0" DATE: 10.04.2019
DRAWN: AM CHECKED: AB
SEAL: SHEET NO.:

I-112.00

COPYRIGHT © ANDREW BERMAN ARCHITECT

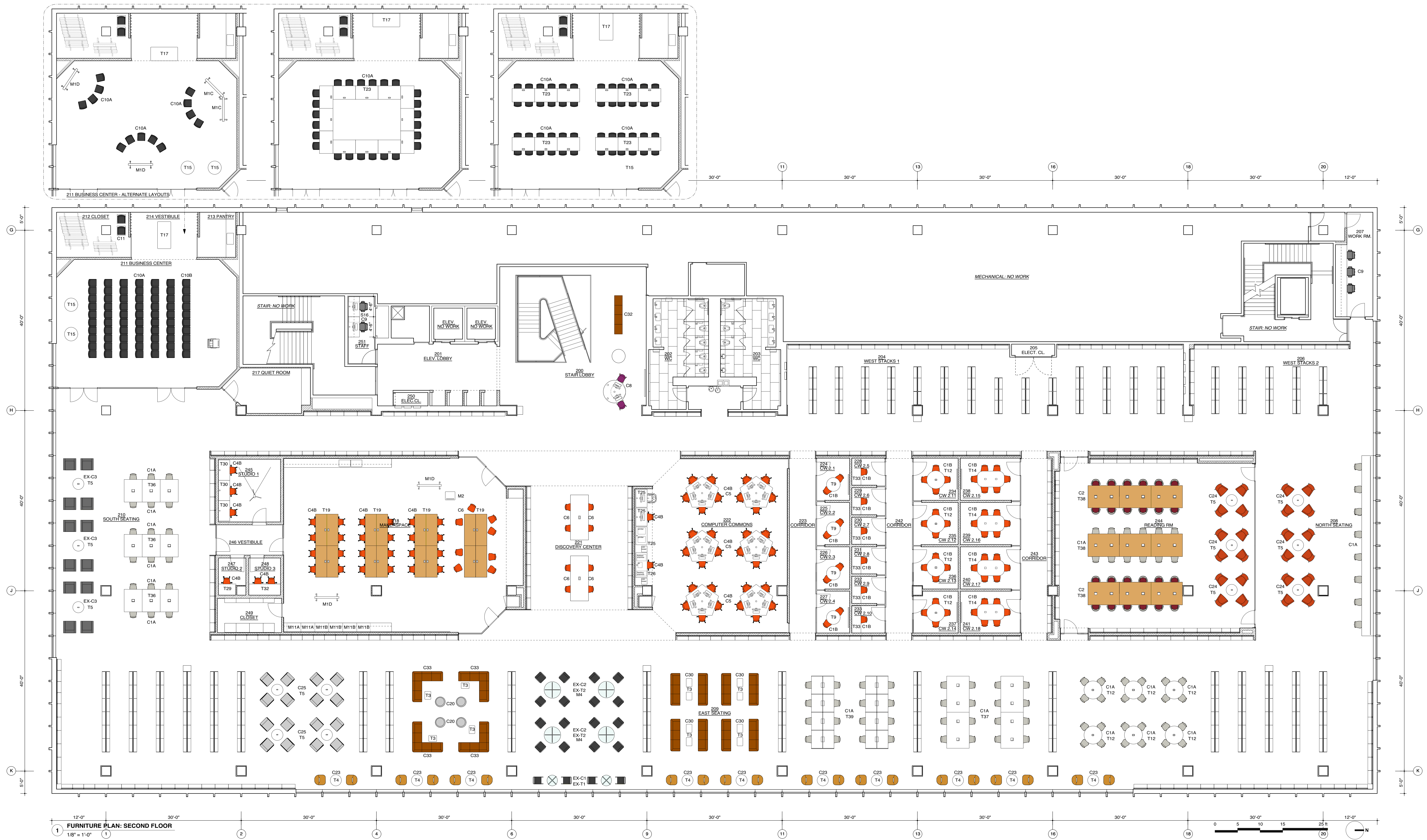

REVISIONS:

ISSUE	DATE
ISSUED FOR PRICING	05.04.2019
SCHEMATIC DESIGN	01.16.2019
DESIGN DEVELOPMENT	04.26.2019
ISSUED FOR SHELVING PRICING	06.03.2019
50% CD	07.16.2019
BID SET	09.30.2019
ADDENDUM #2	10.14.2019
FURNITURE ISSUED FOR BID	11.06.2019

NOTE:
REFER TO FURNITURE SCHEDULE AND FURNITURE SPECIFICATIONS FOR DETAILS.

PROJECT:
SKOKIE PUBLIC LIBRARY
5215 OAKTON STREET
SKOKIE, IL 60077

ARCHITECT:
ANDREW BERMAN ARCHITECT
77 CHAMBERS STREET
NEW YORK, NY 10007
P 212 226 5998

MEP ENGINEER:
WMA CONSULTING ENGINEERS
815 SOUTH WABASH AVENUE
CHICAGO, IL 60605
P 312 870 5104

STRUCTURAL ENGINEER:
THE STRUCTURAL GROUP
707 LAKE COOK ROAD, SUITE 300
DEERFIELD, IL 60015
P 847 562 1977

LIGHTING DESIGNER:
SCHULER SHOOK
750 NORTH ORLEANS, SUITE 400
CHICAGO, IL 60654
P 312 374 4335

ACOUSTICAL CONSULTANT:
THRESHOLD ACOUSTICS LLC
141 WEST JACKSON BLVD, SUITE 2080
CHICAGO, IL 60604
P 312 366 1400

GRAPHICS & WAYFINDING:
NEIL DONNELLY STUDIO
603 BERGEN STREET, 201
BROOKLYN, NY 11238
P 917 373 7471

SHEET TITLE:
**FURNITURE PLAN
SECOND FLOOR**

SCALE: 1/8" = 1'-0" **DATE:** 10.04.2019

DRAWN: AM **CHECKED:** AB

SEAL: SHEET NO.:

I-121.00

COPYRIGHT © ANDREW BERMAN ARCHITECT

BID FORM

The Bidder, _____ (*insert full legal name of bidder*) (“Bidder”), hereby submits the following bid submittal in response to Skokie Public Library’s request for unit priced bids for furniture packages required for the 2020 Library Renovation Project.

1. Bidder acknowledges that it has used the attached Exhibit A, Furniture Schedule, as and for its bid submittal, which is attached to this executed bid form. Bidder acknowledges that its bid submittal, and the prices contained therein, are based upon the Instructions to Bidders, Conditions of Contract, and Contract Specifications as contained in this bid package, along with the information contained in any later-issued Addenda.

2. Bidder acknowledges receipt of the following Addenda:_____.

3. Bidder acknowledges that the Library will determine the lowest responsive and responsible bidder for each specified furniture item, and that each low bidder for each furniture item will be determined on an item by item basis, based upon unit prices. Bidder acknowledges that the Library will award multiple contracts to the lowest responsive and responsible bidder for each specified furniture item based upon unit prices.

4. Bidder acknowledges that the Library’s actual quantities ordered may vary from quantities specified, which is only an estimate.

5. Bidder acknowledges that this bid, and each of its unit prices and extended prices, are firm and irrevocable for a period of sixty (60) days after the date of bid opening.

6. Bidder represents and warrants that it has reviewed, executed and submitted with this bid submittal the Bidder’s Certifications following this bid form, and that each statement made in the certifications is true and correct.

7. Upon the Library’s award of the contract to Bidder, Bidder acknowledges that a contract is formed, and hereby agrees to perform the contract in accordance with the Contract Documents. Bidder acknowledges that if requested by the Library, Bidder will execute a written contract prepared by the Library that incorporates by reference the Contract Documents.

Subscribed and sworn on: Bidder: _____

Date: _____ By: _____

By: _____ Its: _____

Notary Public

Date: _____

Bidder’s Mailing Address:

Bidder’s Email Address:

BIDDER'S CERTIFICATIONS

ELIGIBILITY TO BID

The undersigned hereby certifies that Bidder is not barred from bidding on this Contract as a result of a violation of either the bid-rigging or bid-rotating provisions of Article 33E of the Criminal Code of 1961, as amended.

Name of Bidder (Please Print)

Submitted by (Signature)

NON-COLLUSION AFFIDAVIT

The undersigned certifies that he or she has not, nor has any other member, representative, or agent of the firm, company, corporation or partnership represented by him or her, entered into any combination, collusion, or agreement with any person relative to the price to be bid by anyone at such letting, nor to prevent any person from bidding, nor to induce anyone to refrain from bidding, and this bid is made without reference to any other bid and without any agreement, understanding, or combination with any other person in reference to such bidding. This individual further certifies that no person, firm, or corporation has, or will receive directly or indirectly, any rebate, fee, gift, commission, or thing of value based upon awarding of the contract.

Name of Bidder (Please Print)

Submitted by (Signature)

EQUAL OPPORTUNITY

The undersigned hereby certifies that Bidder is in compliance with the Equal Employment Opportunity Clause and the Illinois Fair Employment Practices Act.

Name of Bidder (Please Print)

Submitted by (Signature)

SEXUAL HARRASSMENT POLICY

The undersigned hereby certifies that Bidder has complied and will comply with the requirement of Section 2-105 of the Illinois Human Rights Act (775 ILCS 5/2-105) with respect to sexual harassment policies. The terms of that law, as applicable, are hereby incorporated into the contract.

Name of Bidder (Please Print)

Submitted by (Signature)

NO SMOKING

The undersigned hereby certifies that Bidder agrees that it and its employees will abide by the Library's no smoking policy at all times during performance of the contract.

Name of Bidder (Please Print)

Submitted by (Signature)

DRUG FREE WORKPLACE

Bidder, if having twenty-five employees or more, does hereby certify that pursuant to Section 3 of the Illinois Drug-Free Workplace Act (30 ILCS 580/3), it shall provide a drug-free workplace for all employees engaged in the performance of services under the contract by complying with the requirements of the Illinois Drug-Free Workplace Act, and further certifies that it is not ineligible for award of this contract by reason of debarment for a violation of the Illinois Drug-Free Workplace Act.

Name of Bidder (Please Print)

Submitted by (Signature)

ADDITIONAL CERTIFICATIONS

The undersigned individual further certifies that:

1. He or she is the duly authorized agent of Bidder; that Bidder has given him / her actual authority to submit this bid; that he / she is expressly authorized by Bidder to execute these certifications on Bidder's behalf; and that the Library may rely upon all certifications submitted.

2. Bidder has reviewed and fully understands the scope of the contract, has completely reviewed the general and specific conditions and requirements of the contract, including all Contract Documents, and is aware of all applicable laws and other requirements.

3. Bidder has the necessary equipment and personnel (including backups) or has documented financial ability and means to acquire the same sufficient to adequately and properly perform the contract.

4. Bidder is the following type of business entity, in good standing with the State of Illinois: _____ (sole proprietorship, partnership, corporation, limited liability company). Bidder is duly authorized by the State of Illinois to conduct business in Illinois.

5. All figures and responses submitted by Bidder on this bid are true, complete, and accurate. All documents attached to and submitted with this bid are true, complete, and authentic.

Name of Bidder (Please Print)

Submitted by (Signature)

END OF BID FORM.